

CE PROPlus Electronic Panel

User Manual



AKO-15640

Index	Page
1.- Presentation	3
1.1.- Maintenance	3
1.2.- Cautions	3
2.- Battery	3
3.- Recommendations	4
4.- Installation	5
5.- Wiring	6
5.1.- Pressure switch wiring options.....	7
6.- Description	8
6.1.- Quick access to functions	8
6.2.- Status LEDs	9
6.3.- Messages.....	9
7.- Programming menu	10
7.1.- Basic initial configuration	10
8.- Operation	13
8.1.- Compressor control	13
8.2.- Defrost control	15
8.3.- Fan control.....	17
8.4.- Light control.....	17
8.5.- Pump down function	18
8.6.- Alarms	19
8.7.- Data logging	20
8.8.- HACCP logging	21
9 Advanced configurations	22
9.1.- Digital inputs.....	22
9.2.- Auxiliary relay	23
9.3.- Access code (password).....	24
9.4.- Parameter transfer	24
9.5.- Return to initial parameters	24
9.6.- Program version	24
10.- Connectivity	25
11.- Parameters	26
12.- Technical specifications	31

AKO Electromecánica thanks you and congratulates you on the purchase of our product, the development and manufacture of which involved the most innovative technologies, as well as rigorous production and quality control processes.

Our commitment to achieving customer satisfaction and our continuous efforts to improve day by day are confirmed by the various quality certificates obtained.

This is a high performance, technologically advanced product. Its operation and the final performance achieved will depend, to a great extent, on correct planning, installation, configuration and commissioning. Please read this manual carefully before proceeding to install it and respect the instructions in the manual at all times.

Only qualified personnel may install the product or carry out technical support.

This product has been developed for use in the applications described in the manual. AKO Electromecánica does not guarantee its operation in any use not foreseen in this document and accepts no liability in the case of damage of any type which may result from incorrect use, configuration, installation or commissioning.

Complying with and enforcing the regulations applying to installations where our products are destined to be used is the responsibility of the installer and the customer. AKO Electromecánica accepts no liability for damage which may occur due to failure to comply with these regulations. Rigorously follow the instructions described in this manual.

In order to extend the lifetime of our products to the maximum, the following points must be observed:

- Do not expose electronic equipment to dust, dirt, water, rain, moisture, high temperatures, chemical agents or corrosive substances of any type.

- Do not subject equipment to knocks or vibrations or attempt to handle them in any way differently to that indicated in the manual.

- Do not under any circumstances exceed the specifications and limitations indicated in the manual.

- Respect the indicated environmental conditions for operation and storage at all times.

- During installation and on completion of this, avoid the presence of loose, broken or unprotected cables or cables in poor condition. These may constitute a risk for the equipment and its users.

AKO Electromecánica reserves the right to make any modification to the documentation and the product without prior notification.

1.- Presentation

PROPlus is the global electronic solution to manage positive and negative cold room stores, in combination with:

- Standard condensing units
- Streamlined condensing units
- Or as a service panel in decentralised systems.

It has a general circuit breaker of up to 16A, high IP65 degree of protection for installation in damp environments, is easy to install thanks to its new connection strip and intuitive menus with help texts that make programming easier using its backlit LCD display.

1.1.- Maintenance

Clean the surface of the unit with a soft cloth, water and detergent. Do not use abrasive detergents, petrol, white spirits or solvents.



Units that include rechargeable electrical accumulators:

This unit includes accumulators that should be replaced when the unit's battery life is under the duration assigned in its specifications. At the end of the useful life of the unit, the accumulators should be taken to a selective waste collection centre or returned to the manufacturer.

1.2.- Cautions

-Using the unit not observing the manufacturer's instructions may alter the appliance safety requirements. Only probes supplied by AKO should be used for the unit to operate correctly.

-From -40 °C to +20 °C, if the NTC probe is extended to 1000 m with at least 0.5 mm² cable, the maximum deviation will be 0.25 °C (cable for probe extension ref. AKO-15586).

-Only NTC probes supplied by AKO should be used for the appliance to operate correctly.

-The **AKO-15640** should be installed in a place protected from vibrations, water and corrosive gases, where the ambient temperature does not exceed the value indicated in the technical data.

-For the reading to be correct, the probe should be used in a place without heat influences apart from the temperature you want to measure or control.

-Always disconnect the power supply to do the wiring. The power supply circuit should have a main switch and residual current protection outside the panel (according to 2 2 R.E.B.T.). The power supply cable will be H05VV-F 2x2.5 mm² or H05V-K 2x2.5 mm².



IMPORTANT:

- The function of each probe depends on the "probe setting" parameter (See probe configuration on page 11).
- The AUXILIARY relay is programmable, and its operations depends on the configuration (See page 23).
- The function of the digital inputs depends on the configuration (See page 22).
- The recommended currents and powers are the maximum working currents and powers.

2.- Battery

You should connect the battery cable (1) and plate connector (2) before installing the unit.

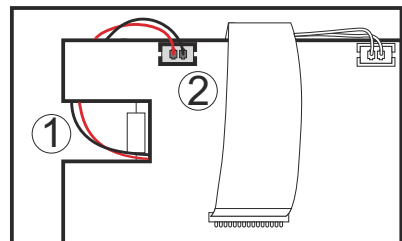

3.- Recommendations

ATTENTION!!

Disconnect the voltage before carrying out any operations inside the electrical panel.

All wiring should be according to current standards and should be carried out by authorised staff.

Only carry out the wiring foreseen in the wiring diagrams.

- Working ambient temperature: 0 °C to 50 °C
- Rated isolation voltage $U_i = 440 V\sim$
- Electrical panels with IP65 degree of protection
- CEM 1 Environment
- Terminals for copper conductors
- Resistance to short-circuits $I_{cc}=4.5 kA$

Panel installation:

Do not knock or move the panel abruptly.

Carry out the wiring according to the installation manual.

The probes and their cables should **NEVER** be installed in a conduit together with power, control or feeder cables.

The earth terminals that the panels contain are installed to guarantee the continuity of earthing, however, earthing is not carried out by the terminal and should be carried out outside the panel.

The neutral ratings are TT or TNS. The IT rating should not be used.

Circuit breakers (protective switches) are of the phase/s + neutral, curve C type, guaranteeing switching and protection against overcurrent.

Close the panel when you are not working on it.

Main switch connection and residual current protection outside the electrical panel according to low voltage electrotechnical regulations.

Checks before starting the panel up:

The power supply voltages and frequencies will be those indicated in the table and diagram corresponding to each panel model.

Check that there are no loose parts or foreign bodies on connections or switchgear.

Check that there is no dust or damp inside the panel.

Check the correct fastening of the switchgear and components.

Check the correct tightening of the screws and power connections.

Check the correct connection of the power conductors.

Check the correct insulation of the outer lines and that they do not mechanically force the inner connections of the panel.

Checks during the panel start-up:

Check that no electric arcs occur.

Check that the relays or contactors do not produce ratios.

Check that there is no overheating in cables, controllers and the rest of the switchgear.

Checks after the first 24 hours of operation:

Check that no overheating occurs.

Retighten screws and power connections.

Periodical preventive maintenance:

The panel should remain closed using its anchors.

Retighten the power connections once a year.

Check the wear of the switchgear once a year.

4.- Installation

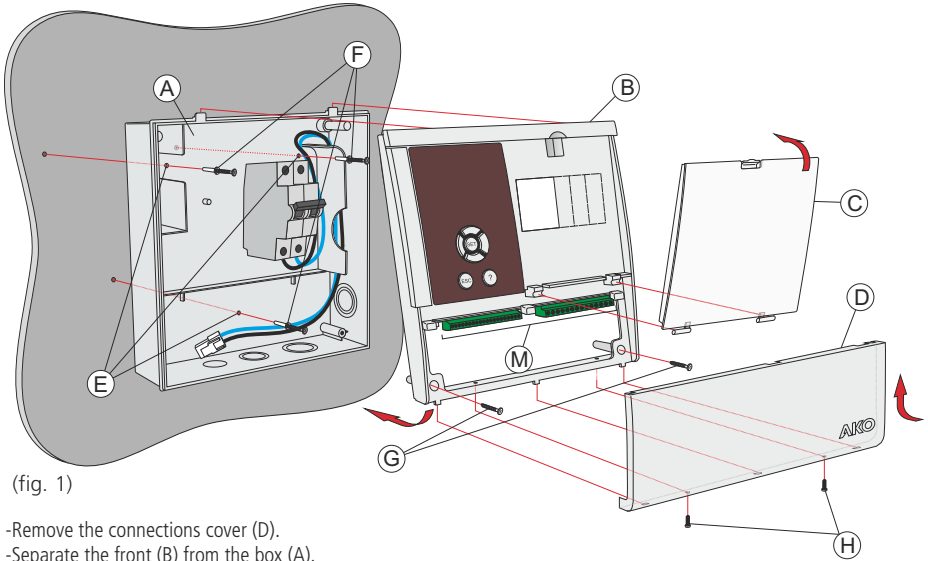

(fig. 1)

(fig. 2)

POWER SUPPLY INPUT
230Vac +10% -15%
50/60Hz ±3Hz

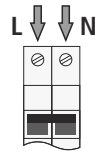

CONNECT ALL EARTH
CONNECTIONS IN
THIS TERMINAL

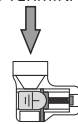

- Remove the connections cover (D).
- Separate the front (B) from the box (A).
- Choose the most suitable cable entry for the facility (fig. 3).
- Make the holes for the glands using the pre-drilled centres as a guide.
- Drill 3 holes on the wall following the box fixing holes (E) (fig. 4).
- Insert and tighten the 3 screws + plug (F).
- Insert the cables through the glands. Use the passing area shown in figure 3 for cable guiding.
- Connect the battery (See page 3)
- Connect the power supply inlet to the circuit breaker as indicated in figure 2.
- Assemble the front on the box (B) carefully making sure that the cables are not pinched.
- Insert and tighten the two screws on the front (G).
- Connect the cables following the diagrams in section 5.
- Close the connections cover (D), insert and tighten the fixing screws (H).

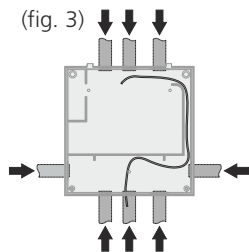

(fig. 3)

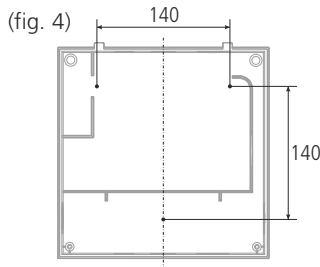

(fig. 4)

5.- Wiring

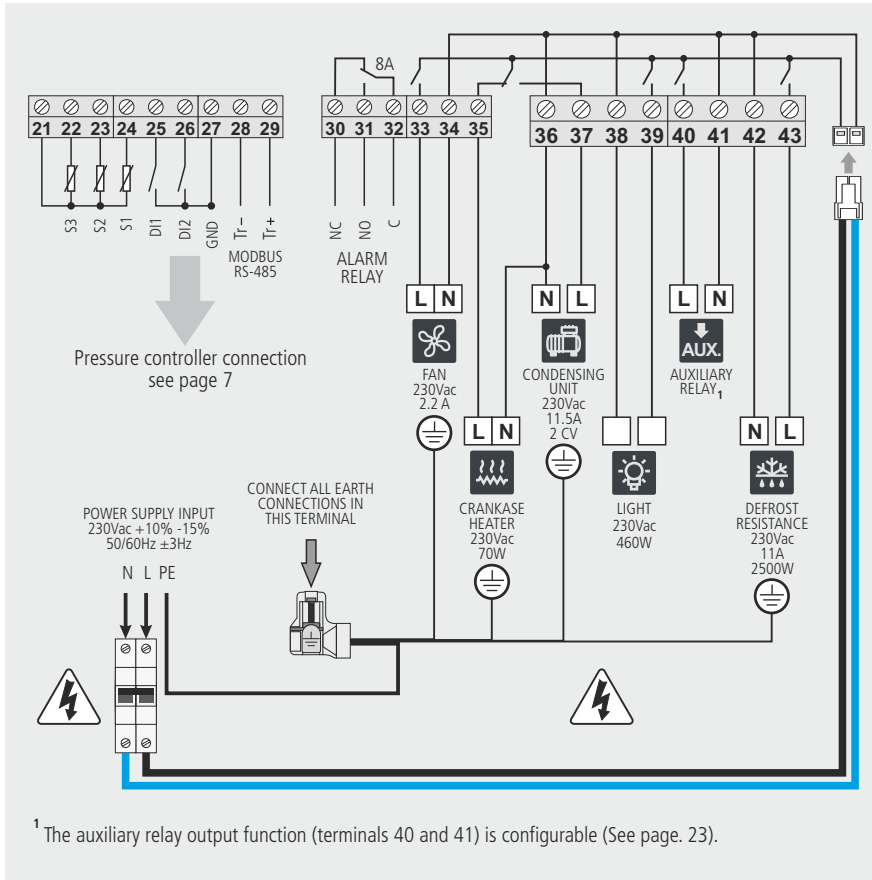

ATTENTION: Make sure to turn of the equipment's power supply before handling it, as different areas may be energised.

IMPORTANT

- The recommended currents and powers are the maximum working currents and powers.
- The function of each probe depends on the "probe configuration" parameter (See page 11).
- Remember that the control probe and registration probe should be configured separately if you want to comply with EN12830.

5.1.- Pressure switch wiring options

Combined High/Low pressure controller

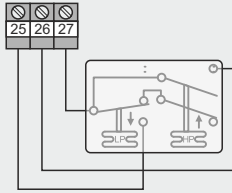

Configuración (See page. 28)

Input 1 configuration: Low pressure input
Input 1 polarity: Normally open
Input 2 configuration: Severe external alarm
Input 2 polarity: Normally open
Aux. relay configuration: Pump down control

Separate Low and High pressure controller

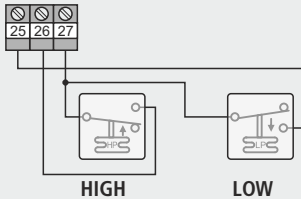

Configuración (See page. 28)

Input 1 configuration: Low pressure input
Input 1 polarity: Normally open
Input 2 configuration: Severe external alarm
Input 2 polarity: Normally open
Aux. relay configuration: Pump down control

3 terminal High - Low pressure-controller

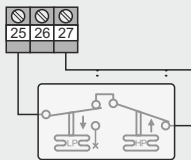

Configuración (See page. 28)

Input 1 configuration: Low pressure input
Input 1 polarity: Normally closed
Aux. relay configuration: Pump down control

Pressure controller equivalence

HIGH / LOW

DANFOS
/ PENN



ALCO

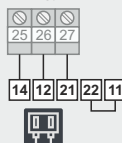

RANCO



6.- Description

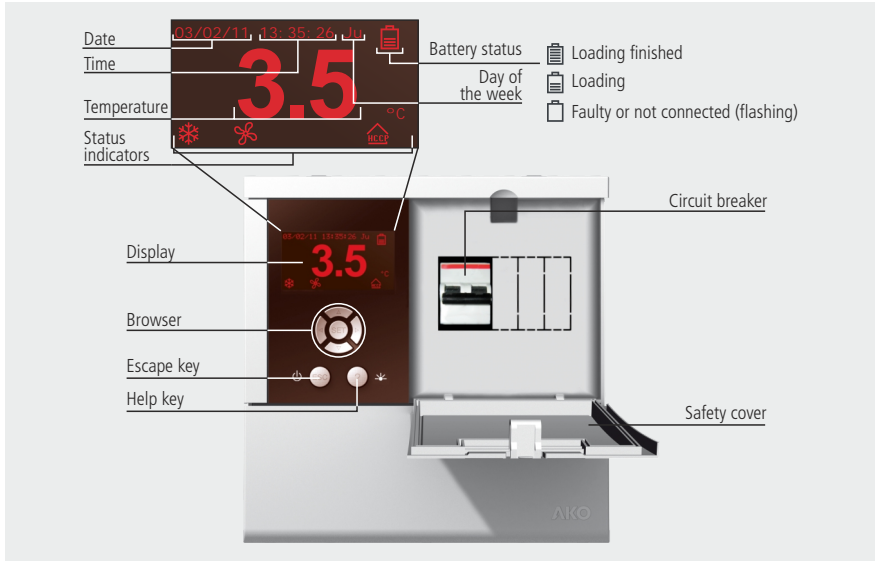

6.1.- Quick access to functions

	Pressing it for 5 seconds activates or deactivates the defrost.		Pressing it for 5 seconds allows changing the SET POINT temperature.
	Pressing it for 5 seconds activates or deactivates the AUX relay. (According to config. see page 23).		Pressing it for 5 seconds activates or deactivates the CONTINUOUS CYCLE.
	Pressing it for 5 seconds accesses the log list (See page 20).		Pressing it for 5 seconds accesses the HCCP events log (See page 21).
	Pressing it for 5 seconds accesses the display contrast setting, press ▲ and ▼ to change it.		Pressing it for 5 seconds allows editing the description of the unit (See page 12).
	Silences the alarms (they are indicated on the display).		It activates or deactivates the cold room light (terminals 38 and 39). This function stays active although the unit is in the ⏻ mode.
	Pressing it for 5 seconds activates or deactivates the Stand-By mode. The display shows the ⏻ symbol in this mode.		

6.2.- Status LEDs



Permanent: Compressor relay active.
Flashing: It must be activated, but it is not due to a parameter.



Defrost relay activated.



Continuous cycle mode active.



Alarm active.



Flashing: Alarm silenced + alarm relay deactivated.



Auxiliary relay activated by key.



Auxiliary relay indicating the unit's status (ON/OFF).



Auxiliary active relay in pump down mode.



Permanent: Fan relay activated.
Flashing: It must be activated, but it is not due to a parameter.



Defrost ended by time (See page 15).



Light relay activated.



Energy saving mode active (See page 13).



Permanent: HACCP function active.
Flashing: HACCP alarm stored not displayed (See page 21).



Auxiliary relay activated per digital input.



Auxiliary relay active in second defrost mode.



Auxiliary relay active copying relay status for compressor.

6.3.- Messages

ACCESS CODE:

Access code (password) request to enter to the programming menu or to change the set point.

DEFROST:

Indicates that a defrost is being performed.

THERMOSTAT CONTROL:

The thermostat control function is active (See page 13).

EXTERNAL ALARM / SEVERE EXT. ALARM:

External alarm / severe external alarm activated by one of the digital inputs.

HIGH TEMP. ALARM / LOW TEMP. ALARM:

The temperature of probe 1 exceeds / is lower than the parameter programmed in Maximum alarm probe 1 / Minimum alarm probe 1.

L. PRESSURE ALARM:

The low pressure controller has triggered due an excessively low pressure in the low pressure circuit, adjustment stops.

ERROR PROBE 1, 2, or 3:

Probe 1, 2 or 3 broken (circuit open, crossed or temperature > 110 °C or temp. < -55 °C).

7.- Programming menu

It allows configuring the operating parameters.

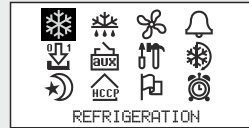

The programming menu allows adjusting the unit's parameters to the installation's needs.

Press the **SET** key for 5 seconds to access the programming menu. If the access code is activated, a 2 digit code is requested (See page 24), if the code entered is not correct the unit will not enter programming.

The parameters are grouped by functions in 12 separate menus, to access a given menu, select it using the browser and press **SET** (For more details, consult page 26).

Function of the keys in programming



Moves the selection up, or increases the value of the parameter.



Moves the selection down or decreases the value of the parameter.



Moves the selection to the left.



Moves the selection to the right.



Accepts the value or accesses the selected menu.



Allows exiting a parameter without saving the changes, returning to the previous menu or exiting programming.



Displays the help for the selected parameter or function.

7.1.- Basic initial configuration



Language

It defines the language of the menus and helps displayed on the screen.



Set point (SP)

It defines the temperature that should be inside the cold storage room (See page 13):

- Minimum: -40.0 *
- Maximum: 320 *

*(Depends on the bottom/top locking of the set point).

Calibration of Probe 1

It allows correcting the temperature detected by probe 1, this is particularly useful when the probe cannot be located in the ideal place.



Connected sensors

Choose the correct option according to the no. of probes connected:

- Sensor 1: If it has just one control probe. Defrost will end by time.
- Sensor 1 and 2: If it has two probes, a control probe and another one for defrost (evaporator).
- Sensor 1 and 3: If it has two probes, one for control and another for data logging or product temperature (according to **Probe setting**), defrost will finish by time.
- Sensor 1, 2 and 3: If it has three probes, one for control, and another for defrost and another for data logging or product temperature (according to **Probe setting**).

Sensors to be displayed

It defines which probe will be displayed on the screen (probe 1, probe 2 or probe 3).

Display mode

It defines the information displayed on the screen during normal operation:

- Probe and clock: It displays the probe defined in the **Sensors to be displayed** parameter, the date, time and day of the week.
- Probe and text: It displays the probe defined in the **Sensors to be displayed** parameter and the description of the unit (See page 12).
- Probes, clock and text: It displays all the active probes, date, time and day of the week and the description of the unit (See page 12). The configuration of the **Sensors to be displayed** does not intervene in this mode.

Display unit

It defines the temperature display units (° Centigrade or ° Fahrenheit).

Probe setting

It defines the function of the inputs of probe S1 and S3, the function of the S2 input is not configurable.

- **TEM at S1/REG at S3:** The temperature control, alarms and HACCP probe (Probe 1) is connected to the S1 input and the temperature data logger probe (Probe 3) to the S3 input:

TEM at S1/REG at S3 (According to EN 12830)

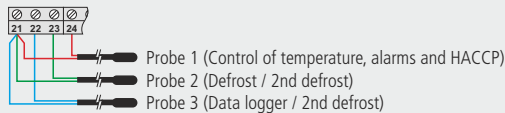

If probe 3 is configured as 2 defrost, the data logging deactivates.

- **TEM and REG at S3:** The temperature control, alarms and HACCP probe is also the data logger probe (Probe 1) and it is connected in input S3, the product temperature probe is connected in the S1 input.

TEM and REG at S3

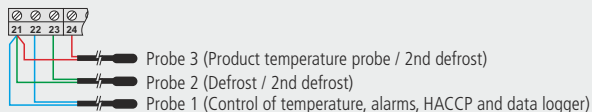

Delay at Start-up

They allow delaying the start up of the installation when it receives electricity. This parameter prevents continuous stoppages and start-ups of the installation in exceptional situations, for example, after a power cut, in test periods or during the commissioning of the installation.

This is established in minutes.

Decimal point

It defines if the degree's decimal points are displayed or not, and therefore the resolution of the unit.



Date

It configures the current date (year, month, day).

Hour

It configures the current time (day of the week, day, minute).



Equipment description

The unit's display can be customised including the description of the installation with a maximum length of 25 characters.

The description will not be displayed if the **Display mode** parameter is configured as "Probe 1 and clock".

To edit the description, press the **SET** and **▶** keys for 5 seconds.

Text editor operation

To change the description, press the **SET** + **▶** keys at the same time.

The changes made during edition are displayed on the bottom of the screen.

- Use the **◀**, **▶**, **▲** and **▼** keys to move around the different characters and options available and the **SET** key to validate the selection.
- Select **✂** to delete the character in grey.
- Select **◀** or **▶** to move around the text being edited.
- Select **☑** to save the changes and exit the edition menu.

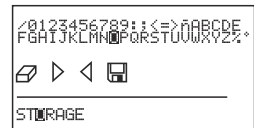
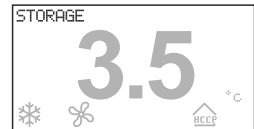

Contrast

To change the contrast of the screen, press the **SET** and **▶** keys for 5 seconds.

Adjust the screen's contrast pressing the **▲** and **▼** keys.

Press **SET** to validate.

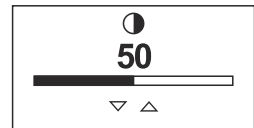

8.- Operation

8.1.- Compressor control

NORMAL OPERATION

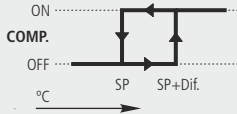

When the temperature in probe 1 reaches the set point value (SP) plus the probe's differential, the compressor activates and makes the temperature drop. When the set point value (SP) is reached, the compressor stops.



CONTROL BY THERMOSTAT

Temperature is controlled by an external thermostat instead of probe 1, and to do so one of the digital inputs must be configured as "Thermostat control".

This configuration cancels the probe inputs, and therefore temperatures will not be displayed nor will the functions associated with them be carried out (temperature, alarms, HACCP logging, etc.).

CONTINUOUS CYCLE MODE

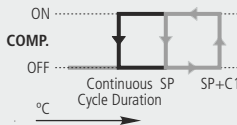

When this mode is activated, the compressor starts to operate continuously and without taking the set point into account, until the time configured in the **Continuous cycle duration** parameter passes, or until the **▶** key is pressed again for 5 seconds.

The unit will immediately return to normal operation.



Use this function to cool the cold rooms before loading products.

It is activate pressing the **▶** key for 5 seconds, the display shows the  icon while this mode is active.

ENERGY SAVING MODE

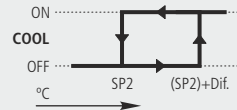

Operation is the same as in the normal ode, but increasing the set point the amount of degrees defined in the **Set point energy saving** parameter.

(SP2= Set point during energy saving)



It allows energy saving in the periods of low activity of the cold room, and in this way reduces the installation's electricity consumption. The display will show the  icon when this mode is active.

It is activated using time programming, using the **Energy saving start** parameter on the  menu with the options:

- **Day:** Defines the days this mode will be activated on;
 - Deact.: It will never be activated.
 - Monday/Tuesday/Wednesday/Thursday/Friday/Saturday/Sunday: It will only activate on the chosen day.
 - Mon-Sun: It will activate everyday (from Monday to Sunday).
 - Mon-Sat: It will activate everyday except Sunday.
 - Mon-Fri: It will activate everyday except Saturday and Sunday.
 - Sat-Sun: It will only activate on Saturday and Sunday.
- **Hour:** It times the energy saving mode start hour.
- **Minute:** It times the energy saving mode start minute.

The **Set point energy saving** parameter defines what the set point will be when this mode is active and the **Energy saving duration** parameter defines the duration of this mode in hours. It never activates if it is configured at 0.

This mode may optionally be activated and deactivated whenever you want using the external button connected to one of the digital inputs, and to do so the corresponding input should be configured as "Remote energy saving".

COMPRESSOR PROTECTION DELAY

This protects the compressor, preventing continuous stops and start-ups in certain exceptional cases.

The **Compressor Protection** parameter allows choosing between 2 types of delay:

OFF-ON: Minimum time the compressor should stay stopped before each start-up.

ON: Minimum time the compressor should stay operating before each start-up.

The **Protection delay time** parameter defines the time of the previous parameter.

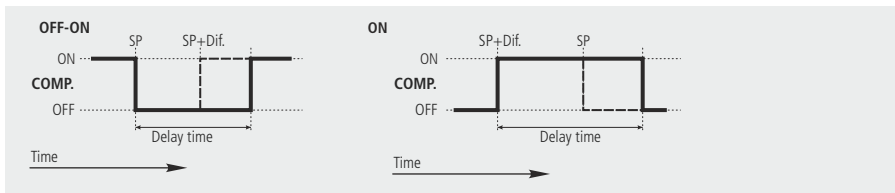

OPERATION IN THE EVENT OF A FAULT IN PROBE 1

If probe 1 fails (failure, disconnection, etc.), the compressor operates according to times programmed in the following parameters:

Compressor ON fault s1: Time of the compressor operating in the event of a fault in probe 1.

Compressor OFF fault s1: Time of the compressor stopped in the event of a fault in probe 1.

SET POINT LOCKINGS

Using the **Set Point upper limit** and **Set Point lower limit** parameters, it is possible to set a top and bottom limit for the **Set point (SP)** parameter, which prevents being able to set a set point that is too low or too high that might damage the installation or the stored product.

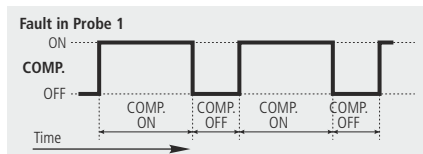

STOP COMPRESSOR WHEN THE DOOR IS OPENED

This defines if the compressor will be stopped whenever the cold room's door is opened. To do so, one of the digital inputs should be configured as "door contact" (See page 22).

If the door stays open longer than the value programmed in the **Inact. with door open** parameter, the compressor will return to normal operation (See page 22).

8.2.- Defrost control

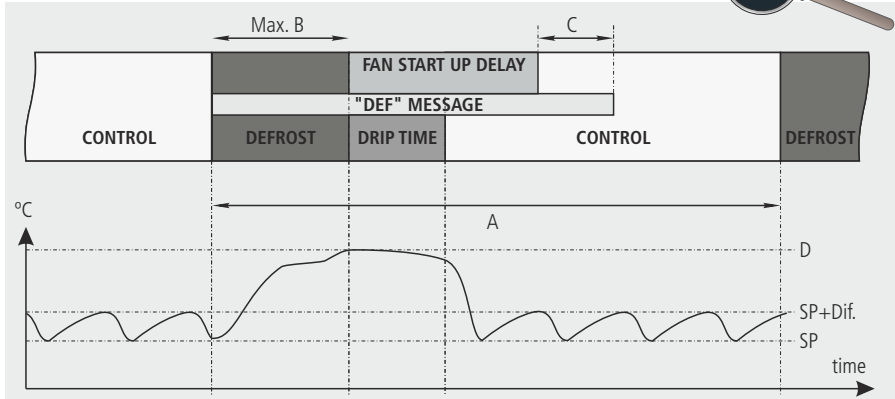

	Description	Parameter
A	Time between two defrost starts	Defrost frequency
B	Maximum defrost duration	Defrost duration
C	Maximum duration of the defrost message	Message duration
D	Final defrost temperature by probe 2	Defrost final temperature
SP	Temperature set point	Set point (SP)
Dif.	Temperature set point differential	Sensor 1 differential



Type of defrost

This is chosen using the **Defrost type** parameter that defines the behaviour of the controller during the defrost process.

Types of defrost	Description	Parameter configuration
Compressor stopping	The compressor stops and defrost is carried out statically.	⚙️ Defrost type: Resistances ⚡ Fans state during defrost: Disconnected
By air	The fans are activated and the compressor stops, defrost is carried out forcing the movement of air through the evaporator.	⚙️ Defrost type: Resistances ⚡ Fans state during defrost: Connected
By resistances	The defrost resistances are activated and the compressor stops, defrost is carried out by the heat supply from the resistances.	⚙️ Defrost type: Resistances ⚡ Fans state during defrost: Disconnected
By Cycle inversion	A 4-way valve is activated that inverts the cooling generator circuit and the compressor starts up, forcing the defrost.	⚙️ Defrost type: Reverse cycle ⚡ Fans state during defrost: Disconnected
By simple hot gas	A valve is activated that sends the discharge from the compressor to the evaporator inlet. Using check valve prevents the hot gas from returning along the liquid line.	⚙️ Defrost type: Reverse cycle ⚡ Fans state during defrost: Disconnected



Defrost start

Defrost will start if:

- The time programmed in the **Defrost frequency** parameter has passed since the start of the last defrost. The parameter **Defrost mode** defines how this time is counted:
 - **Frequency:** Total time passed between defrost starts.
 - **Compressor sum:** Total time of the compressor operating between defrost starts.
 - **Real Time Clock:** Defrost starts when one of the times programmed in the **Defrost 1 to 8** on the  menu is reached. (The defrost frequency is not taken into account).
- We press the  key for 5 seconds.

End of defrost

The defrost stops if:

- The temperature programmed in the **Defrost final temperature** has been reached in probe 2 (this requires having a defrost probe connected to S2).
- The time configured in the **Defrost duration** has passed (maximum defrost duration). The  icon is shown on the display if the **Signals end defrost time** parameter is configured in "Yes".
- We press the  key for 5 seconds.



REMARK: If the **Defrost duration** is configured to 0, no defrosts are carried out.

Drip time after defrost

This is established using the **Drip time** parameter of the  menu and defines the time added at the end of the defrost to allow removing any water left in the evaporator.

During this time, the compressor and fans will be stopped (except if the defrost is by air).

Message displayed during defrost

This is established using the **Defrost message** parameter, and you can choose between displaying the real temperature captured by probe 1, show the temperature capture by probe 1 at the start of the defrost, or display the DEFROST message.

The **Message duration** parameter defines how long this message is displayed, after the drip time and start up delay of the fans (See page 15).

Other parameters

Using the **Defrost at Start-up** parameter, you can configure if the unit carries out or not a defrost when it receives power (first start up or after a fault in the power supply).

If the "YES" option is chosen, defrost starts after the time defined in the **Defrost delay at Start-up** parameter on the  menu.

2nd defrost

It operates in the same way as the defrost, but acts on the auxiliary relay, controlled by probe 2 or 3 and is used to control the defrost in a second evaporator. (The AUX relay must be configured as 2nd defrost).

The configuration parameters of the 2nd defrost are configured from the  menu.

Remote defrost

This function allows activating the defrost of the unit using an external button, connecting it to one of the digital inputs that must be configured as "remote defrost".

8.3.- Fan control

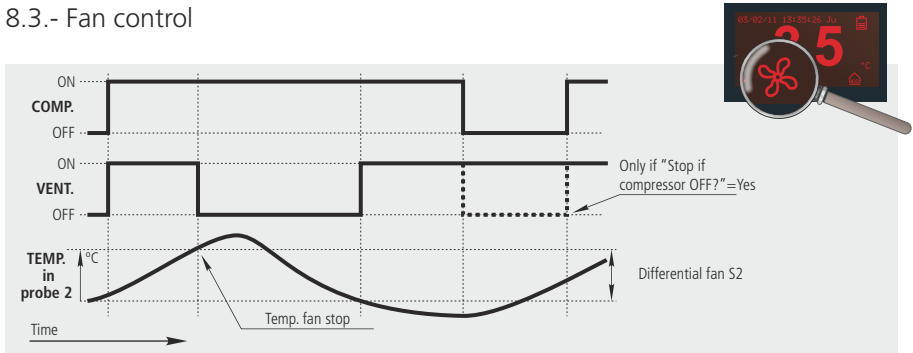

Fan control is carried out using probe 2 and taking the following parameters into account:

- **Fan stop temperature:** It defines the temperature at which the fans stop.
- **Fans differential s2:** It defines the temperature differential of probe 2 (evaporator).
- **Stop when compressor OFF?:** It defines if the fans stop in each compressor stop.
- **Fans state during defrost:** It defines the status of the fans during the defrost.
- **Fans delay after defrost:** It configures the time that passes before starting the fans up, at the end of a defrost.
- **Stop when opening door:** It defines if the fans are stopped when the cold room's door is opened (this requires having configured one of the digital inputs as door contact).
If the door stays open longer than the value programmed in the **Inact. with door open** parameter, the fans return to normal operation.

If probe 2 is not connected or an error in the probe is detected, the fans will always be operating without taking into account the temperature related parameters, but taking the rest of the parameters into account.

8.4.- Light control

The unit has an additional relay to control the cold room's lights.

Just press the ? key to turn the lights on/off.

This function is even active when the unit is in Stand-by.

Light timing

The unit activates the lights whenever the cold room's door is detected to have been opened, and turns them off after the time programmed in the **Cold room light timing** parameter, even though the door stays open. If time is configured at "0", timing does not start.

One of the digital inputs should be configured as "Door contact".



8.5.- Pump down function

This function foresees problems in the compressor caused by movements of coolant, using a stop/start technique of the installation, controlled via the liquid solenoid, the low pressure controller and the compressor itself.

The auxiliary relay must be configured as "Pump down control", the liquid solenoid must be connected to the 40 and 41 terminals and there must be a low pressure controller connected as indicated in the diagrams (See page 7).

STOP

When the temperature in probe 1 reaches the set point (SP) value, the liquid solenoid closes.

Due to the compressor continuing to operate (COMP. relay ON), the pressure drops quickly in the evaporator, and therefore activates the low pressure controller and the compressor stops.

If during this process the low pressure controller does not detect the change of pressure, the controller will stop after the safety time defined in **Pump down duration**.

START

When the temperature in probe 1 reaches the set point value plus the differential, the liquid solenoid opens, making the pressure in the evaporator increase and deactivating the low pressure controller, which will start the compressor up.

When a balance is reached between the high and low pressure before the start up, this is much gentler and lengthens the life of the compressor.

If after a time after opening the liquid solenoid the low pressure controller does not deactivate, the controller closes the solenoid again and activates the low pressure alarm. This time is defined using the **Pump down On delay** parameter.

STAND-BY WITH PUMP DOWN

If the pump down function is active and the compressor is operating, when the Stand-by function starts the unit stops the compressor in a controlled manner as explained in the "STOP" section and displays on the screen the "Pump down" message, and when it has finished, it automatically goes to the Stand-by mode.

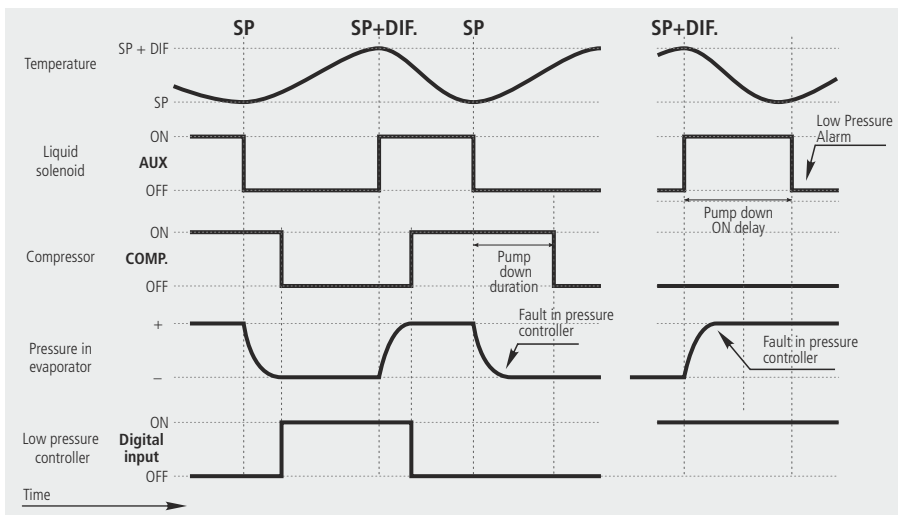

8.6.- Alarms

The unit warns the user with a message on the screen of the activation of a relay or the activation of an acoustic signal in certain circumstances, according to the programming of the following parameters:



Alarm configuration

It defines how the values of the different temperature alarms are defined:

Relative to the SP: They are defined indicating the temperature variation regarding the set point for the alarm to activate. This option enables us to change the set point without having to reset the maximum and minimum alarms.

Absolute: They are defined indicating the absolute temperature value for the alarm to activate.

Maximum / minimum temperature alarm

It displays the message "HIGH TEMP.ALARM" or "LOW TEMP.ALARM" when the temperature in probe 1 reaches the value configured in the **Maximum alarm sensor 1** and **Minimum alarm sensor 1** parameters respectively.

The sound alarm and alarm relay is activated.

Alarm differential

It establishes the differential for the maximum and minimum alarm parameters (hysteresis).



Example

We configure the following parameters in a controller:

Set point=2, Maximum alarm probe 1=10, Alarm differential=2

- If it is configured as "Relative to the SP", the maximum temperature alarm activates when 12 degrees are reached in probe 1, and deactivates when 10 degrees are reached.
- If it is configured as "Absolute", the maximum temperature alarm activates when 10 degrees are reached in probe 1, and deactivates when 8 degrees are reached.

Delays

They define the delay time in minutes from a certain event, until the activation of the temperature alarms.

- **Temperature alarm delay:** Delay from when the temperature is reached.
- **Start-up delay:** Delay from which the unit receives power supply (start up or after a fault in the power supply). This allows starting up the installation avoiding constant alarm statuses.
- **Alarm delay after defrost:** Delay at the end of a defrost.
- **On-Off door alarm delay:** Delay from the deactivation of the digital input configured as door contact.
- **Off-On door alarm delay:** Delay from the activation of the digital input configured as door contact.

Alarm relay after key

This defines the status of the alarm relay after silencing it (pressing the **ESC** key).

External alarm / severe external alarm

It displays the **EXTERNAL ALARM** or **SEVERE EXT. ALARM**, on activating the digital input configured as external alarm or severe external alarm. The severe external alarm also stops the unit's control functions (compressor, fans, defrost and auxiliary relay).

One of the digital inputs must be configured as external alarm or as severe external alarm.

The sound alarm and alarm relay is activated.

Defrost finished by time alarm

The icon  is displayed when a defrost ends for maximum time. (The **Signal end defrost time** must be configured as "Yes").

The sound alarm and alarm relay is not activated.

Low pressure alarm

It displays the **LOW PRESSURE ALARM** message when low pressure is detected in the circuit, or if pressure does not increase during the starting operation from pump down (See page 18). In both cases, there should be a low pressure controller connected to the unit (See page 7).

The compressor stops and activates the sound alarm and alarm relay is not activated.

8.7.- Data logging





Display of the logged data.

08/05/09*15:30 S=15 N059
07/05/09 15:30 S=15 N058
06/05/09 15:30 S=15 N057
05/05/09 15:30 S=15 N056
04/05/09 15:30 S=15 N055
03/05/09 15:30 S=15 N054
02/05/09 15:30 S=15 N053
01/05/09 15:30 S=15 N052

It allows displaying the temperatures logged during the selected time period.

The probe designed for temperature logging depends on the probe configuration (See page 11).



Press the  and  keys at the same time for 5 seconds to access data logging.

Data is saved in log blocks and the unit can store up to 366 blocks and each block contains 96 logs.

Each log contains the temperature measured by the unit, and the data and time of this measurement.

The "**registry interval**" parameter defines the time that passes between the capture of a datum and the next one.

When the last available block (N365) has been completed, the unit starts again with the first block (N000), therefore, the time interval the unit is capable of storing depends on the configured log interval.

Use the  or  keys to select a block and press **SET** to display the logged data.

Block in use	08/05/09*15:30 S=15 N059	
	07/05/09 15:30 S=15 N058	
	06/05/09 15:30 S=15 N057	
Log date	04/05/09 15:30 S=15 N055	Block no.
	03/05/09 15:30 S=15 N054	
Log time	02/05/09 15:30 S=15 N053	Log interval
	01/05/09 15:30 S=15 N052	

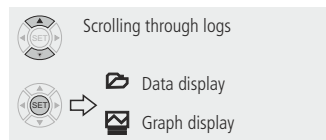

📄-Data display

It displays the data logged in the selected block on the screen.

Log date	05/05/09 14:30	8.2°	82	Log no.	First log: 00 Last log: 95
Log time	05/05/09 15:15	8.5°	95	Log value	

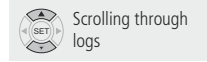

The name of each block indicates the date and time of its first log, but when it is displayed, the first datum displayed is the last log of the block.

05/05/09 15:30 S=15 N056	05/05/09 15:15 8.5° 95
04/05/09 15:30 S=15 N055	05/05/09 15:00 8.6° 94
03/05/09 15:30 S=15 N054	05/05/09 14:45 8.4° 93

📈-Graph display

It displays the graph with the data logged in the selected block on the screen.

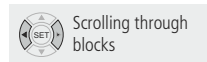
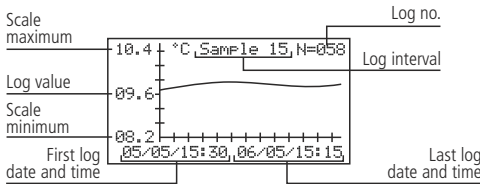

8.8.- HACCP logging

(Hazard analysis and critical control points)

It logs events that might endanger the integrity of the products stored in the cold store room.

If the cold room exceeds the temperature indicated in the **"Maximum alarm in sensor 1"** parameter, for longer than indicated in the **"HACCP alarm delay"** parameter (📄 menu), the unit logs an HACCP event.

If the 📄 flashes, it indicates that a new HACCP event has been logged.

If this event occurs caused by a fault in the power supply, this is indicated in the log.



Event date	Event time	HACCP ,P. Failure, °C	Type of selected event
09/03/11 15:23	01	18.1	P. Failure: Power failure
06/02/11 08:45	03	20.3	Temperature: High temperature
05/01/11 22:30	F02	25.2	
14/10/10 11:05	09	17.2	
05/08/10 19:53	F03	18.6	Power supply fault



9 Advanced configurations

9.1.- Digital inputs



Function of the digital inputs

```

input 1 configuration
input 1 alarm delay
input 1 Polarity
input 2 configuration
input 2 alarm delay
input 2 Polarity
Inact. with door open
Cold room light times
    
```

They allow the unit to react in certain external events, and their configuration depends on the component that is connected and has the following options:

- **Input configuration (1 or 2):** It defines the behaviour of digital input 1.
 - Disabled: It does not carry out any function.
 - Door contact: Using a contact installed in the cold room door, it allows conditioning certain functions of the unit to the door status (if the compressor/fans stop when opened, delay the activation of the alarms, etc.).
 - External alarm: It activates the unit's external alarm (See page 19), it can be used as activation of pressure pre-alarms.
 - Severe external alarm: It activates the unit's severe external alarm (See page 19), stopping the installation. It can be used as activation of pressure alarms.
 - Remote defrost: It activates the defrost remotely, for example using an external button.
 - Remote energy saving: It activates energy saving remotely, for example using an external button.
 - AUX activation: It activates/deactivates the auxiliary relay depending on the status of the input. The auxiliary relay must be configured as "Activated by input" (See page 23).
 - Low pressure input: It activates the low pressure alarm (See page 20) and allows controlling the pump down function (See page 18).
 - Thermostat control: It uses this function to adjust the temperature using an external thermostat. This function is usually used when the refrigerator unit has its own built-in thermostat. (See page 13).
- **Input alarm delay (1 or 2):** It defines the time that passes from when the signal is received until the alarm is activated. It only works if the input is configured as external alarm, severe external alarm or low pressure input.
- **Input polarity (1 or 2):** It defines the type of contact present in the digital input (1 or 2);
 - Normally open: The input activates when the contact closes.
 - Normally closed: The input activates when the contact opens.
- **Inact. with door open**: It determines the inactivity time of the compressor and/or fans after the cold room door is opened. (It requires one of the digital inputs to be configured as "Door contact"). This allows the installation to continue to operate if the door is accidentally left open.
It only acts if one of the **Stop compressor when opening door** or **Stop fans when opening door** parameters is at "Yes".



9.2.- Auxiliary relay



Auxiliary relay function.

```
AUX relay configuration
Defrost 2 duration
Defrost 2 final temp.
Defrost 2 sensor
Pump Down duration
Pump Down On delay
Press. controller confis.
```

This menu is used to configure the different operating options of the auxiliary relay:

- **AUX relay configuration:** It defines the operation of the auxiliary relay.
 - Disabled: It does not carry out any function.
 - Activated by key: The relay is activated/deactivated pressing the  key for 5 seconds.
 - Activated by input: The relay activates/deactivates according to the status of the digital input, and to do so, one of the digital inputs should be configured as "AUX relay activation" (See page 22).
 - Equal state equipment: The relay stays active when the unit is operating, and disconnects when it goes to Stand-by mode or when the power supply is interrupted.
 - 2nd Defrost: It controls the defrost of the second evaporator (See page 16).
 - Pump down control: It controls the liquid solenoid valve in the stop and start processes with pump down (See page 18).
 - Equal compressor state: The auxiliary relay is activated/deactivated by copying the compressor status (terminals 36 and 37).
- **Defrost 2 duration:** It defines the maximum duration of the second defrost.
- **Defrost 2 final temp.:** It defines the end temperature of the second defrost.
- **Defrost 2 sensor:** It defines which probe controls the second defrost:
 - Disabled: No probe controls the second defrost, it always ends by maximum time, according to the **Duration defrost 2** parameter.
 - Probe 2: Probe 2, located in the main evaporator, acts as master, stopping both defrosts when the temperature configured in the **Defrost final temperature** parameter of the  menu is reached.
 - Probe 3: Probe 3, located in the secondary evaporator, stops the second defrost when the temperature configured in the **Defrost 2 final temp.** parameter is reached.



IMPORTANT: If probe configuration has been defined as "TEMP at S1/REG at S3", the log is not carried out.

- **Pump down duration:** It defines the maximum safety time for the stop operation in the pump down mode (See page 18).
- **Pump down On delay:** It defines the maximum safety time for the start-up operation in the pump down mode (See page 18).

9.3.- Access code (password)

It allows protecting the configuration of the unit using a 2 digit code (from 01 to 99). If it is active a code is requested when you try to access the programming menu. This menu cannot be accessed if a wrong value is entered. The code is defined using the **Access password** parameter of the **00** menu.

The **Password to Set Point** parameter defines if this code is requested on changing the set point.

9.4.- Parameter transfer

This function allows transferring the programmed parameters of a device to others, using the **AKO-14923** programming key. This will save a lot of time when configuring similar devices.

The **AKO-14923** key does not require an external power supply, and is powered by the device itself.

9.4.1 Transfer parameters from the device to the key

Disconnect the unit power supply.

Connect the programming key in the parameter server connector.

Connect the unit power supply.

In the programming menu, select the option **00/Transfer parameters/Send**.

Disconnect the unit power supply.

Disconnect the device programming key.

9.4.2 Transfer parameters from the key to the device

Disconnect the unit power supply.

Connect the programming key in the parameter server connector.

Connect the unit power supply.

In the programming menu, select the option **00/Transfer parameters/Receive**.

Disconnect the unit power supply.

Disconnect the device programming key.

9.5.- Return to initial parameters

This function configures all the unit's parameters to its default values, i.e., as it leaves the factory. The date and time data are not changed.

To return the unit to the initial parameters, select the **00/Initial parameters/Yes** in the programming menu.

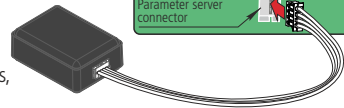
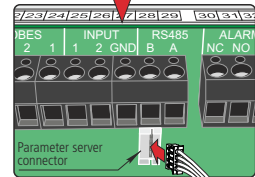
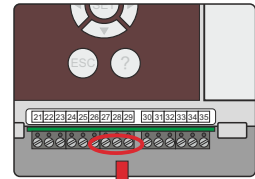

WARNING: Any change made in the unit's configuration will be lost.

9.6.- Program version

The **Program version** parameter in the **00** menu allows displaying the firmware version installed in the unit. Use this information if you have to ask for advice from the technical assistance service.

11.- Connectivity

The unit has a port for RS485 data connection (MODBUS), which can be managed using a PC.

Up to 127 units can be connected to a PC with **AKONet (AKO-5010)**, or to the **AKO-5012** web server. Each of these units should have a different MODBUS address, that is defined using the **Communication address** of the  menu.

Using the **AKONet** software it is possible to display and capture the data of any connected unit, and configure its parameters.

AKONet: Management software for AKO units with RS485 (MODBUS) communication. If it is installed in a server the software can be accessed from any PC in the network or even from Internet (it requires the server having connection to Internet and fixed IP).

AKO-5012: Web server that includes the **AKONet** software. It can carry out the same functions as the PC, with the advantage of having a server dedicated to communication with the units.

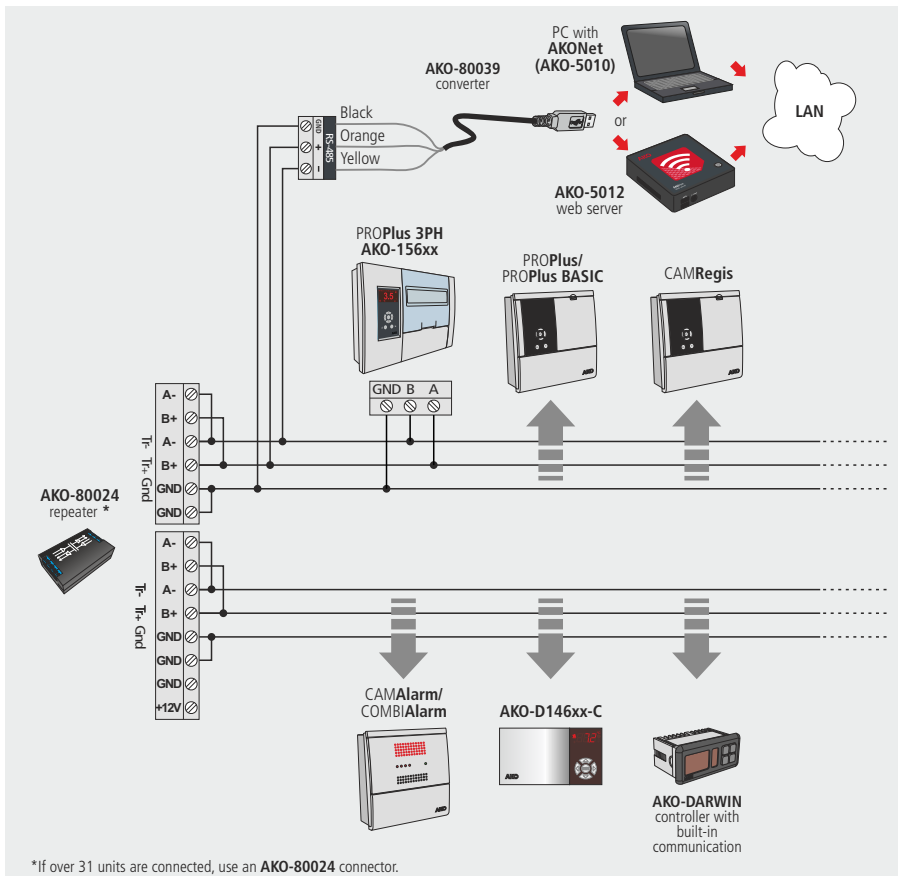

12.- Parameters

The programming menu allows adjusting the unit's parameters to the installation's needs.

Press the **SET** key for 5 seconds to access the programming menu. If the access code is activated, a 2 digit code is requested (See page 24), if it is not correct the unit will not enter programming.

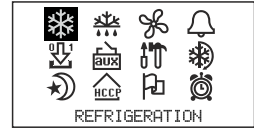

The parameters are grouped by functions in 12 separate menus, to access a given menu, select it using the browser and press **SET**.

The **Def.** column indicates the default parameters.

Temperature values are expressed in **°C** (equivalent temperature in **°F**).

REFRIGERATION control (Compressor)



Description	Page	Units	Min	Def	Max.
Set Point	10	(°C/°F)	-40	0.0	320
Sensor 1 differential	13	(°C/°F)	0.1	1.0	20.0
Calibration of probe 1	10	(°C/°F)	-20.0	0.0	20.0
Set point upper limit (it cannot be set above this value)	14	(°C/°F)	B.I.	99.9	320
Set point lower limit (it cannot be set below this value)	14	(°C/°F)	-40.0	-40.0	B.S.
Compressor protection OFF/ON (From the last disconnection) ON (to the connection)	14			OFF/ON	
Protection delay time	14	(min.)	0	0	255
Compressor ON fault s1 (If it is 0, it will always be stopped)	14	(min.)	0	10	255
Compressor OFF fault s1 (If it is 0, it will always be running)	14	(min.)	0	5	255
Stop when opening door? (It requires a digital input configured as door contact)	14			No	

DEFROST control



Description	Page	Units	Min	Def	Max.
Defrost type: Electrical heater Reverse cycle	15			Res	
Defrost count: Frequency Compressor sum Real time clock	16			Fre.	
Defrost frequency (Time between two starts)	16	(h.)	0	6	120
Defrost duration	16	(min.)	0	30	255
Defrost message: Current temperature Defrost Start temperat DEFROST message	16			DEF	
Message duration (Time added at the end of the defrost)	16	(min.)	0	5	255
Defrost final temperature	16	(°C/°F)	-40.0	8.0	99.9

Description	Page	Units	Min	Def	Max.
Defrost at Start-up	16			No	
Defrost delay at Start-up	16	(min.)	0	0	255
Signals end defrost time	16			No	
Drip time	16	(min.)	0	1	255

FAN control



Description	Page	Units	Min	Def	Max.
Fans stop temperature (controlled by probe 2) (Probe 2 should be active)	17	(°C/°F)	-40.0	4.0	99.9
Fans differential s2	17	(°C/°F)	0.1	1.0	20.0
Stops when compressor OFF?	17			No	
Fans state during defrost Connected Disconnected	17			Dis.	
Fans delay after defrost	17	(min.)	0	3	255
Stop when opening door? (It requires a digital input configured as door contact)	17			No	

ALARM control



Description	Page	Units	Min	Def	Max.
Alarm configuration: Relative to the SP Absolute	19			Rel.	
Maximum alarm in sensor 1 (limits according to the alarm configuration)	19	(°C/°F)	A. Min.	50.0	320
Minimum alarm in sensor 1 (limits according to the alarm configuration)	19	(°C/°F)	-40.0	50.0	A. Max.
Alarm differential	19	(°C/°F)	0.1	1.0	20.0
Temperature alarm delay	19	(min.)	0	30	255
Start-up alarm delay	19	(min.)	0	0	255
Alarm delay after defrost	19	(min.)	0	0	255
On-Off door alarm delay	19	(min.)	0	0	255
Off-On door alarm delay	19	(min.)	0	0	255
Alarm relay after key (After pressing the ESC key, alarm silenced): Connected Disconnected	19			Con.	

DIGITAL INPUT control



Description			Page	Units	Min	Def	Max.
Input 1 configuration :	Disabled	Door contact	22			Dis.	
Severe external alarm	Remote defrost	External alarm					
AUX activation	Low pressure input	Remote energy saving Thermostat control					
Input 1 alarm delay			22	(min.)	0	0	255
Input 1 polarity:			22			NC	
Normally open – The input is activated on closing the contact							
Normally closed – The input is activated on opening the contact							
Input 2 configuration :	Disabled	Door contact	22			Dis.	
Severe external alarm	Remote defrost	External alarm					
AUX activation	Low pressure input	Remote energy saving Thermostat control					
Input 2 alarm delay			22	(min.)	0	0	255
Input 2 polarity:			22			NC	
Normally open – The input is activated on closing the contact							
Normally closed – The input is activated on opening the contact							
Inact. with door open (time)			22	(min.)	0	0	255
Cold room light timing			17	(min.)	0	0	255

AUXILIARY RELAY control



Description			Page	Units	Min	Def	Max.
Aux. relay configuration:	Disabled	Equal state equipment	23			Dis.	
Activated by key	Activated by Input	Equal compressor state					
2nd defrost	Pump down control		23	(min.)	0	30	255
Defrost 2 duration			23	(°C/°F)	-40.0	8.0	99.9
Defrost 2 final temp.			23				
Defrost 2 sensor:	Probe 2	Probe 3	23			Dis.	
Disabled							
Pump down duration			23	(Sec.)	1	30	1800
Pump down On delay			23	(Sec.)	0	60	60

GENERAL STATUS



Description	Page	Units	Min	Def	Max.
Access password (to parameters and set point)	24		00	00	99
Password to Set Point	24			No	
Initial parameters (configures the default values and exits programming)	24			No	
Registry interval	20	(min.)	0	15	60
Communication address	25		0	1	255
Parameters transfer: Disabled Send – The unit sends the parameters to the programming key Receive – The unit receives the parameters from the programming key	24			Dis.	
Connected sensors: Sensor 1 Sensor 1 and 2 Sensor 1 and 3 Sensor 1, 2 and 3	11			S1	
Sensors to be displayed	11		1	1	3
Display mode: One sensor and clock One sensor and text Sensor, clock and text	11			S1 and r.	
Display unit	11		°C	°C	°F
Decimal point	12			Yes	
Probe setting: TEM at S1/REG at S3: Control probe connected in S1 and log probe in S3 TEM and REG at S3: Control and log probe connected in S3	11			TEM in S1	
Delay at Start-up	12	(min.)	0	0	255
Type of operation (not selectable)				Cold	
Program version (Information)	24				

CONTINUOUS CYCLE



Description	Page	Units	Min	Def	Max.
Continuous cycle duration	13	(h.)	0	1	24

ENERGY SAVING



Description	Page	Units	Min	Def	Max.
Set point energy saving	13-14	(°C/°F)	–40.0	0	320
Energy saving duration	13-14	(h.)	0	0	24

HACCP



Description	Page	Units	Min	Def	Max.
HACCP alarm delay (after a temperature alarm) (0=Events log deactivated)	21	(min.)	0	1	255

LANGUAGE



Description	Page	Units	Min	Def	Max.
Language: Español English Français Deutsch	10				

CLOCK



Description	Page	Units	Min	Def	Max.
Date (Year, Month, Day)	12				
Hour (Day of the week, Hour, Minute)	12				
Defrost 1 (Day, Hour, Minute)	16				
Defrost 2 (Day, Hour, Minute)	16				
Defrost 3 (Day, Hour, Minute)	16				
Defrost 4 (Day, Hour, Minute)	16				
Defrost 5 (Day, Hour, Minute)	16				
Defrost 6 (Day, Hour, Minute)	16				
Defrost 7 (Day, Hour, Minute)	16				
Defrost 8 (Day, Hour, Minute)	16				
Energy saving start (Day, Hour, Minute)	13				

12.- Technical specifications

Power supply	230V~ +10% -15% 50/60 Hz ±3 %
Total maximum current	16 A
COMPRESSOR relay	20A to 250V, cos φ=1
AUX relay	16A to 250V, cos φ=1
LIGHT relay	16A to 250V, cos φ=1
FAN relay	8A to 250V, cos φ=1
DEFROST relay	30A to 250V, cos φ=1
ALARM relay	8A to 250V, cos φ=1
Probe temperature range	-40.0 °C to 99.9 °C
Resolution, setting and differential	0.1 °C
Thermometric precision	± 1 °C s/ EN 12830 and EN 13485
Tolerance of the NTC probe at 25 °C	± 0.4 °C
Input for NTC probe	AKO-149xx
Maximum input power	24 VA
Working ambient temperature	0 °C to 50 °C
Storage ambient temperature	-30 °C to 70 °C
Installation category	II s/ EN 61010-1
Pollution degree	II s/ EN 61010-1
Protection degree	IP65
Double isolation between power supply, secondary circuit and relay output.	
Logger battery life if the power supply fails	48 hours
Battery	Li-Polymer for logger
Internal buzzer	
Encapsulated assembly	



AKO ELECTROMECÁNICA, S.A.L.

Av. Roquetes, 30-38 | 08812 Sant Pere de Ribes | Barcelona | España

Tel. (34) 938 142 700 | Fax (34) 938 934 054 | e-mail: ako@ako.com | www.ako.com

We reserve the right to supply materials slightly different to those described in our Data Sheets. Updated information in our web site.

351564022 REV.03 2015