

**AKO ELECTROMECÁNICA, S.A.L.**  
Avda. Roquetes, 30-38  
08812 • Sant Pere de Ribes.  
Barcelona • Spain.

[www.ako.com](http://www.ako.com)

Nos re Nos reservamos el derecho de suministrar materiales que pudieran diferir levemente de los descritos en nuestras Hojas Técnicas. Información actualizada en nuestra web.

We reserve the right to supply materials that might vary slightly to those described in our Technical Sheets. Updated information is available on our website. Nous nous réservons le droit de fournir des matériels pouvant être légèrement différents de ceux qui sont décrits dans nos fiches techniques. Information remise à jour dans notre page web.

Geringfügige Änderungen der Materialien gegenüber den Beschreibungen in den technischen Datenblättern vorbehalten. Aktualisierte Informationen finden Sie auf unserer Website.

Reservamo-nos o direito de fornecer materiais que podem divergir ligeiramente dos materiais descritos nas nossas Fichas Técnicas. Informações atualizadas no nosso website servamos el derecho de suministrar materiales que pudieran diferir levemente de los descritos en nuestras Hojas Técnicas. Información actualizada en nuestra web.

3516524A21 Rev.03 2023

## A: InI= 1, 4

1: Sólo InI=1 / Only InI=1 / Uniquement InI = 1 / Nur InI=1 / Só InI=1

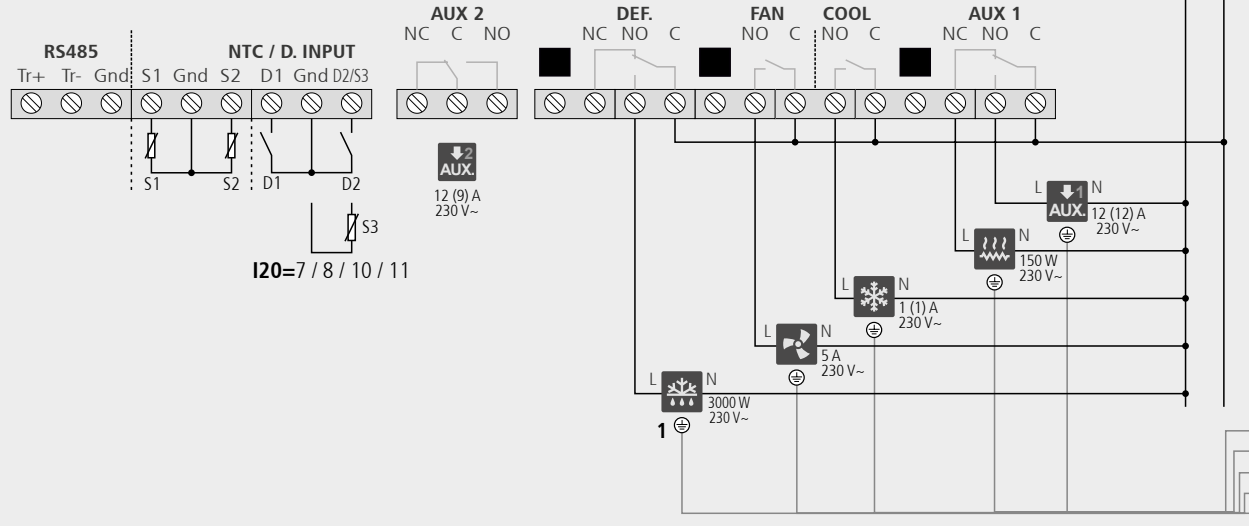

- COMPRESOR  
COMPRESSOR  
COMPRESSEUR  
KOMPRESSOR  
COMPRESSOR
- RESISTENCIA DE CÁRTER  
CRANKCASE RESISTOR  
RÉSISTANCE DU CARTER  
WIDERSTAND DES SCHUTZKASTENS  
RESISTÊNCIA DE CÁRTER
- VENTILADOR  
FAN  
VENTILATEUR  
LÜFTER  
VENTILADOR
- RESISTENCIA DESESCARCHE  
DEFROST RESISTOR  
RÉSISTANCE DÉGIVRAGE  
ABTAUUNGSWIDERSTAND  
RESISTÊNCIA DEGELO
- SOLENOIDE  
SOLENOID  
SOLENOÏDE  
MAGNETVENTIL  
SOLENOIDE
- VÁLVULA DE HOT GAS  
HOT GAS-VALVE  
SOUPAPE DE GAZ CHAUD  
HEISSGAS-KLAPPE  
VÁLVULA DE HOT GAS

## B: InI= 2, 3, 5, 6



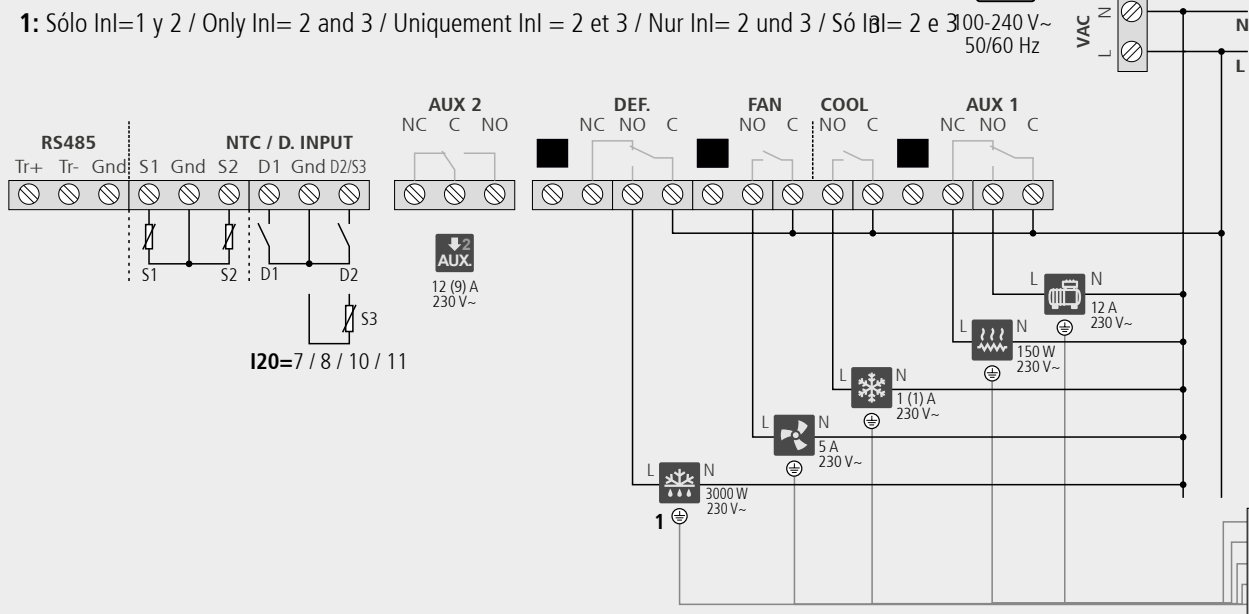



1: Sólo InI=1 y 2 / Only InI= 2 and 3 / Uniquement InI = 2 et 3 / Nur InI= 2 und 3 / Só InI= 2 e 3

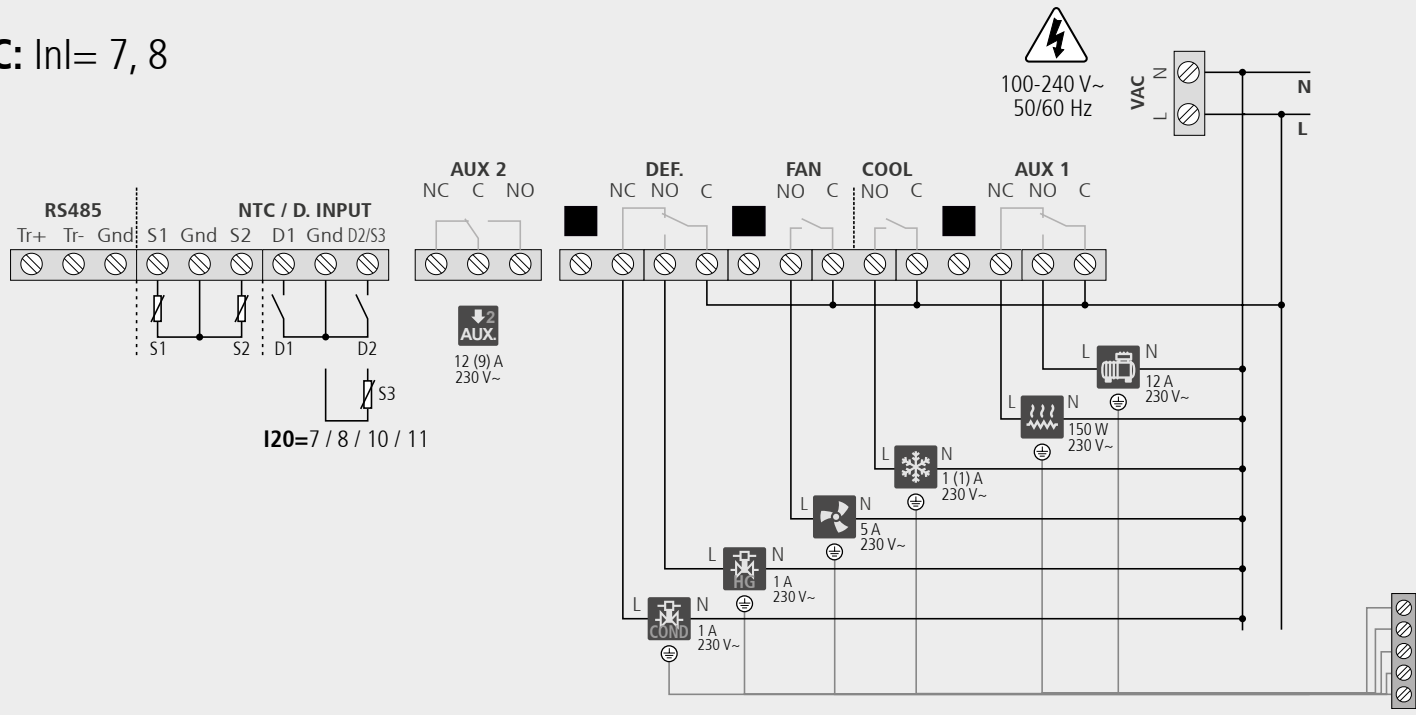

- SOLENOIDE DE CONDENSADOR  
PARA HOT GAS  
CONDENSER SOLENOID  
FOR HOT GAS  
SOLENOÏDE DE CONDENSATEUR  
POUR GAZ CHAUD  
MAGNETVENTIL DES  
KONDENSATORS FÜR HEISSGAS  
SOLENOIDE DE CONDENSADOR  
PARA HOT GAS
- RELÉ AUXILIAR 1  
AUXILIARY RELAY 1  
RELAIS-AUXILIAIRE 1  
HILFS-RELAIS 1  
RELÉ AUXILIAR 1
- PRESOSTATO ALTA-BAJA  
HIGH-LOW PRESSURE CONTROLLER  
PRESSOSTAT HAUTE-BASSE PRESSION  
ÜBER-/UNTERDRUCKWÄCHTER  
PRESSÓSTATO ALTA-BAIXA
- PRESOSTATO ALTA  
HIGH PRESSURE CONTROLLER  
PRESSOSTAT HAUTE PRESSION  
ÜBERDRUCKWÄCHTER  
PRESSÓSTATO ALTA
- PRESOSTATO BAJA  
LOW PRESSURE CONTROLLER  
PRESSOSTAT BASSE PRESSION  
UNTERDRUCKWÄCHTER  
PRESSÓSTATO BAIXA

C: Inl= 7, 8



-  COMPRESOR  
COMPRESSOR  
COMPRESSEUR  
KOMPRESSOR  
COMPRESSOR
-  RESISTENCIA DE CÁRTER  
CRANKCASE RESISTOR  
RÉSISTANCE DU CÁRTER  
WIDERSTAND DES SCHUTZKASTENS  
RESISTÊNCIA DE CÁRTER
-  VENTILADOR  
FAN  
VENTILATEUR  
LÜFTER  
VENTILADOR
-  RESISTENCIA DESESCARCHE  
DEFROST RESISTOR  
RÉSISTANCE DÉGIVRAGE  
ABTAUUNGSWIDERSTAND  
RESISTÊNCIA DEGELO
-  SOLENOIDE  
SOLENOID  
SOLENOÏDE  
MAGNETVENTIL  
SOLENOIDE
-  VÁLVULA DE HOT GAS  
HOT GAS-VALVE  
SOUPAPE DE GAZ CHAUD  
HEISSGAS-KLAPPE  
VÁLVULA DE HOT GAS

 Inl= 2, 5, 7,

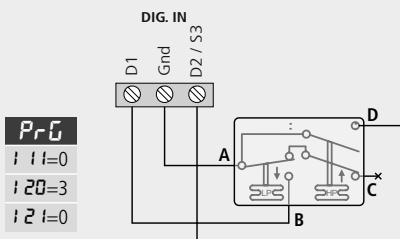
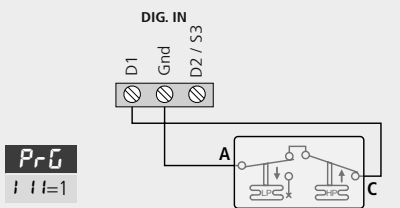

 +  Inl= 2, 5, 7

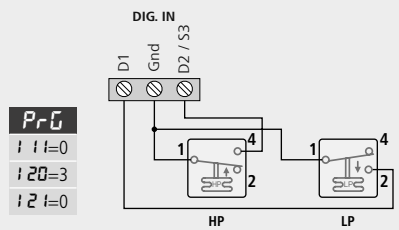

RESISTENCIA DRENAJE O MARCO PUERTA /  
DRAINAGE OR DOOR FRAME RESISTOR /  
RÉSISTANCE DE DRAINAGE OU DU CADRE DE LA PORTE /  
DRÄNAGE ODER TÜRRAHMEN WIDERSTANDS /  
RESISTÊNCIA DE DRENAGEM OU DA OMBREIRA

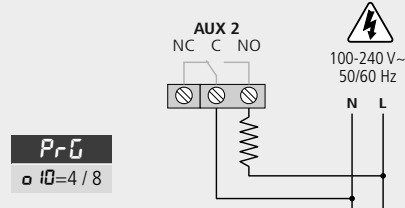

 Inl= 7, 8  
HOT GAS

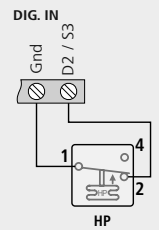

LUZ CÁMARA  
COLD ROOM LIGHT  
ÉCLAIRAGE CHAMBRE  
RAUMBELEUCHTUNG  
LUZ CÁMARA

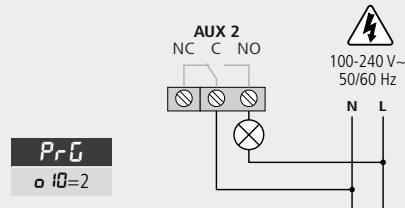

-  SOLENOIDE DE CONDENSADOR  
PARA HOT GAS  
CONDENSER SOLENOID  
FOR HOT GAS  
SOLENOÏDE DE CONDENSATEUR  
POUR GAZ CHAUD  
MAGNETVENTIL DES  
KONDENSATORS FÜR HEISSGAS  
SOLENOIDE DE CONDENSADOR  
PARA HOT GAS
-  RELÉ AUXILIAR 1  
AUXILIARY RELAY 1  
RELAIS AUXILIAIRE 1  
HILFS-RELAIS 1  
RELÉ AUXILIAR 1
-  PRESOSTATO ALTA-BAJA  
HIGH-LOW PRESSURE CONTROLLER  
PRESSOSTAT HAUTE-BASSE PRESSION  
ÜBER-/UNTERDRUCKWÄCHTER  
PRESSÓSTATO ALTA-BAIXA
-  PRESOSTATO ALTA  
HIGH PRESSURE CONTROLLER  
PRESSOSTAT HAUTE PRESSION  
ÜBERDRUCKWÄCHTER  
PRESSÓSTATO ALTA
-  PRESOSTATO BAJA  
LOW PRESSURE CONTROLLER  
PRESSOSTAT BASSE PRESSION  
UNTERDRUCKWÄCHTER  
PRESSÓSTATO BAIXA