

AKO-16526A V2**AKO-16526AN V2**

Advanced temperature and electronic expansion controller for cold room store

User manual

**AKO**

Index	Page
Warnings	3
Maintenance	3
Wiring.....	3
Presentation.....	4
Description.....	5
Installation.....	7
Initial configuration	9
Superheating SET POINT.....	9
Assistant	10
Operation.....	12
SELFDRIIVE mode.....	14
Cold regulation	15
Compressor protection timing.....	19
Door management	20
Management of door frame resistor	20
Defrost.....	21
Management of the drainage resistor	25
Evaporator fans	25
Alarms	26
Alerts.....	28
Light control.....	29
Password	29
Remote Stand-by mode	29
Operation of the auxiliary relays.....	29
Configuration.....	31
Extended programming menu	32
Parameters.....	33
Connectivity	39
Technical specifications.....	40
Simplified declaration of conformity	41

AKO Electromecánica thanks you and congratulates you on the purchase of our product, the development and manufacture of which involved the most innovative technologies, as well as rigorous production and quality control processes.

Our commitment to achieving customer satisfaction and our continuous efforts to improve day by day are confirmed by the various quality certificates obtained.

This is a high performance, technologically advanced product. Its operation and the final performance achieved will depend, to a great extent, on correct planning, installation, configuration and commissioning. Please read this manual carefully before proceeding to install it and respect the instructions in the manual at all times.

Only qualified personnel may install the product or provide technical support.

This product has been developed for use in the applications described in the manual. AKO Electromecánica does not guarantee its operation in any use not foreseen in this document and accepts no liability in the case of damage of any type which may result from incorrect use, configuration, installation or commissioning.

Complying with and enforcing the regulations applying to installations where our products are destined to be used is the responsibility of the installer and the customer. AKO Electromecánica accepts no liability for damage which may occur due to failure to comply with these regulations. Rigorously follow the instructions described in this manual.

In order to extend the lifetime of our products to the maximum, the following points must be observed:

- Do not expose electronic equipment to dust, dirt, water, rain, moisture, high temperatures, chemical agents or corrosive substances of any type.
- Do not subject equipment to knocks or vibrations or attempt to handle them in any way differently to that indicated in the manual.
- Do not under any circumstances exceed the specifications and limitations indicated in the manual.
- Respect the indicated environmental conditions for operation and storage at all times.
- During installation and on completion of this, avoid the presence of loose, broken or unprotected cables or cables in poor condition. These may constitute a risk for the equipment and its users.

AKO Electromecánica reserves the right to make any modification to the documentation and the product without prior notification.

Warnings



-If the device is used without adhering to the manufacturer's instructions, the device safety requirements could be compromised. Only probes supplied by AKO must be used for the unit to operate correctly.

- From -40 °C to +20 °C, if the NTC sensor is extended to 1000 m with at least a 0.5 mm² cable, the maximum deviation will be 0.25 °C (cable for sensor extension ref. **AKO-15586 / AKO-15586H**. Earth the cable mesh at one end only).
- Pt1000 sensors can be extended up to 25m using the **AKO-15586/AKO-15586H** sensor extension cable
- The product should be installed in a place protected from vibrations, water and corrosive gases, where the ambient temperature does not exceed the value indicated in the technical data.
- For the reading to be correct, the sensor should be used in a place without heat influences apart from the temperature you want to measure or control.
- The IP65 protection degree is only valid with the protection cover closed.
- The IP65 protection degree is only valid if the cables enter the device using a tube for electric conductions + gland with IP65 or above. The gland should be the right size for the diameter of the tube used.
- Do not spray the unit directly with high-pressure hoses, as this could damage it.
- This device must be installed in a location where a minimum distance of 20 cm to the human body can be guaranteed, in order to ensure compliance with standards on human exposure to electromagnetic fields.
- The **AKO-16526AN** device must **NEVER** be operating without the internal antenna. This device can be fitted with any antenna provided it has a gain of less than 9.2 dBi and there is a minimum distance of more than 20 cm between it and any person or animal. Any type of antenna used with this device must comply with the limits established for the radio interface in Member States and the following documents: Commission Decision 2010/267/EU of 6 May 2010, ECC Decision (09)03 of 30 October 2009 and CEPT Report 30 of 30 October 2009.

Maintenance

Clean the surface of the unit with a soft cloth, water and soap.

Do not use abrasive detergents, petrol, alcohol or solvents, as this might damage the unit.

Wiring



Always disconnect the power supply to do the wiring.

The probes and their cables must **NEVER** be installed in a conduit together with power, control or power supply cables.

For disconnection, the power supply circuit must be equipped with at least a 2 A, 230 V switch, located near the device. The power supply cable shall be of the H05VV-F or NYM 1x16/3 type. The section to be used will depend on current local regulations, but should never be less than 1.5 mm².

Cables for relay or contactor outputs should have a section of 2.5 mm², allow working temperatures equal to or over 70°C, and be installed with as little bending as possible.

The 120 / 230 V~ wiring area must be kept clear of any other external element.

The wiring setup depends on the options selected in the set-up wizard (See page 10) and on the input and output configurations (See page 37).

Check the enclosed schematic and the defined configuration before wiring.

The parameter St (Type of connected probes) affects all probe inputs. Therefore all connected probes (NTC or Pt1000) must be the same.

IMPORTANT:

- AUXILIARY relays are programmable, and their operation depends on the configuration.
- The function of the digital inputs depends on the configuration.
- The recommended currents and powers are the maximum working currents and powers.

Presentation

The **AKO-16526A / 16526AN** advanced controller for cold room stores has a SELFDRIVE operating mode that automatically controls (without parametrisation) the fans and adaptively minimises defrosts to optimise the performance of the cold room store: maximising time in set point and minimising costs linked to energy consumption and wear of components.

It has an output to regulate the electronic expansion valve. It can be configured so it can control superheating, as well as adjust the cold in the store.

The **AKO-16526AN** controller incorporates a NBIoT communication module that allows it to send operation data to akonet.cloud autonomously.

The different options are:

Temperature control + EEV controlled by PWM

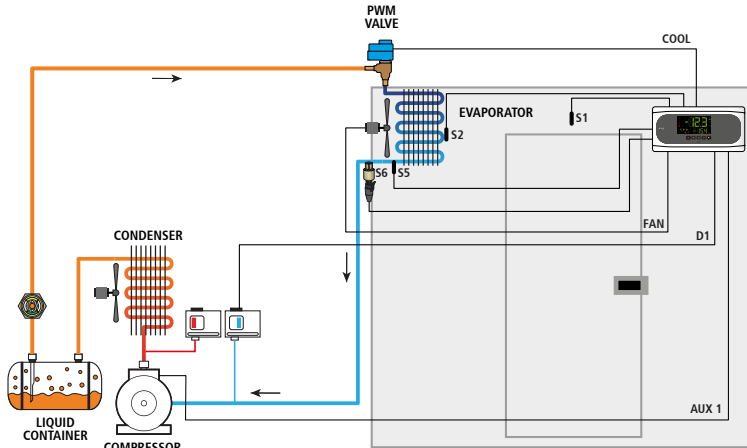

Temperature control + Stepper EEV*

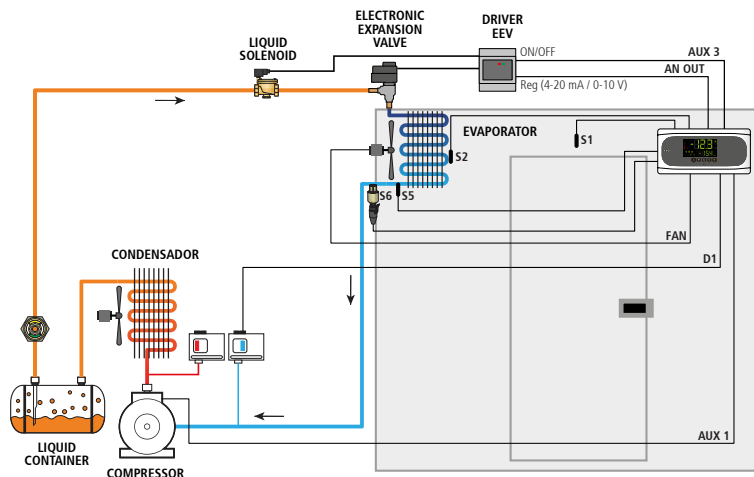





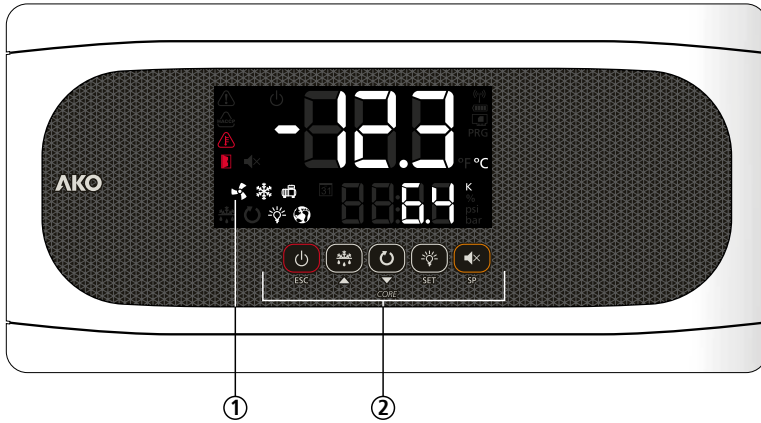











* Requires the use of an external driver controlled by a 0-10 V or 4-20 mA signal. For more information on this option, please see the application note available on our website: [351652632](https://www.ako.com/351652632)

Description



1: Display
2: Keypad

-  **Constant:** Stand-By Mode activated. Regulation is paused.
Flashing: Controlled stop process for the regulation in progress.
-  **Constant:** Cold room door open.
Flashing: The door has been open for a longer time than defined in parameter A12.
-  There is an active alarm (No HACCP or temperature).
-  **Constant:** HACCP alarm active.
Flashing: HACCP alarm recorded and unconfirmed To acknowledge an HACCP alarm, press the  key.
-  The temperature alarm is active.
-  **Constant:** Evaporator fans active.
Flashing: The evaporator fans should be active but something is preventing them from activating.
-  **Constant:** The COOL relay is active.
Flashing: The COOL relay should be active but a delay or protection is preventing this.
Pulsing: Expansion valve regulated.
-  **Constant:** The SELFDRIIVE mode is active.
Flashing: An error has been detected in SELFDRIIVE mode. To view it, press the  key.
-  **Constant:** Compressor active.
Flashing: The compressor should be active but a delay or protection is preventing this.
-  Defrosting active.
-  Continuous cycle mode active.
-  Cold room light active.
-  Alarm in progress muted.
-  °F/°C Temperature displayed in ° Fahrenheit / ° centigrade.
- PRG** Programming mode active.
- K** Lower display showing the real time superheating value.
- %** Lower display showing percentage of EEV opening.
- bar**
psi Lower display showing low pressure in psi / bar.
-  **ON:** Device registered on the NBloT network and with a valid licence.
OFF: Unable to register on the NBloT network or the licence has expired.

Keypad



ESC

Press and hold for 3 seconds to activate/deactivate the Stand-By mode. In this mode, regulation is paused and the icon is displayed.

In the programming menu, it exits the parameter without saving changes and returns to the previous level, or exits programming.



Pressing once without holding displays the temperature of sensor S2 for 10 seconds (if it is enabled). Pressing it for 3 seconds starts/stops the defrost.

In the programming menu, it allows you to scroll through the different levels, or when setting a parameter to change its value.



A brief press shows the SELFDRIVE mode errors.

Pressing it for 3 seconds activates/deactivates the continuous cycle mode.

In the programming menu, it allows you to scroll through the different levels, or when setting a parameter to change its value.



SET

Pressing once without holding activates/deactivates the cold room light.

Pressing it for 3 seconds accesses the condensed programming menu.

Pressing it for 6 seconds accesses the expanded programming menu.

In the programming menu, it accesses the level shown on the display or, during the setting of a parameter, accepts the new value.



SP

Pressing it once without holding it down displays the current effective value of the temperature Set Point in the upper display and the superheating set point in the lower display, taking into consideration temporary changes due to other parameters.

When an alarm is in progress, pressing once without holding mutes the acoustic alarm.

Pressing for 3 seconds accesses the temperature Set Point setting.



ESC



SET

Only AKO-16526AN: Pressing the **SET** and **ESC** buttons for 3 seconds forces the transmission to the cloud via NBloT connectivity.

**STAND-BY**

If the regulation cannot be stopped immediately due to its configuration, a controlled stop process starts and the icon flashes. To stop the controlled stop process and force Stand-by, press the Stand-by key again for 3 seconds.

Installation

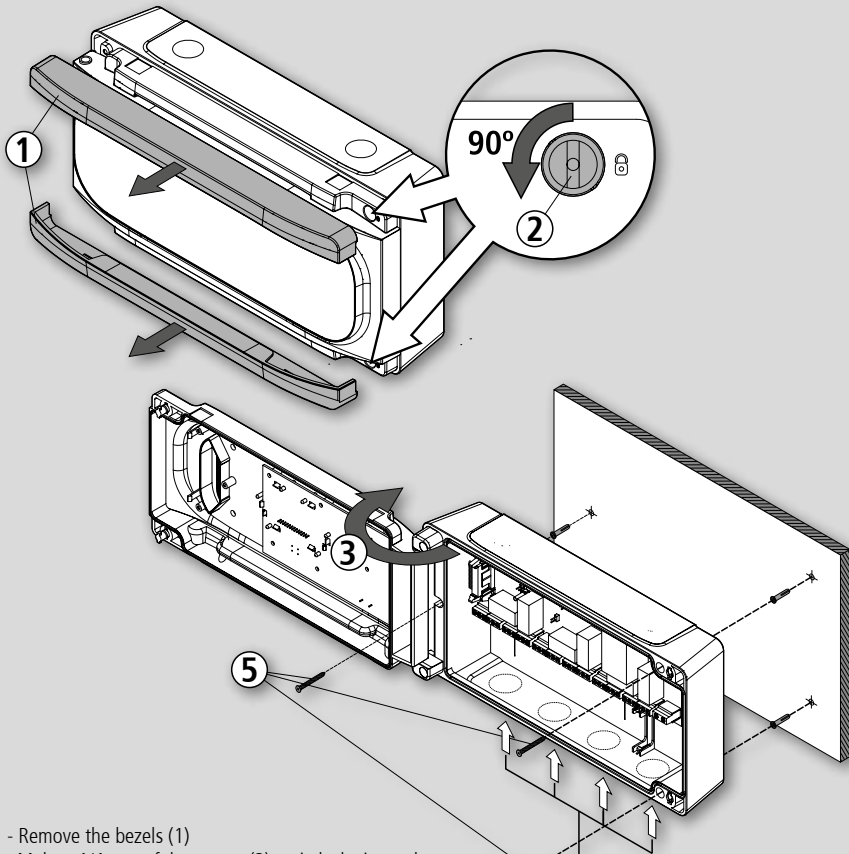

- Remove the bezels (1)
- Make a 1/4 turn of the screws (2) anti-clockwise and open the door (3).
- Install the necessary glands (4 / 5) by drilling holes in the points indicated on the box.
- Mark and make the holes in the wall with the aid of the template included.
- Fix the device to the wall. If it is a brick wall, use the screws and plugs supplied; if the wall is made of sheet metal (cold room store), use the screws provided without plugs (6).
- Wire the device by following the recommendations indicated on page 3.
- Close the cover (3), tighten the screws (2) and replace the bezels (1).



ATTENTION: When drilling the holes for the glands, take care to avoid damaging the internal components.

AKO-16526AN: DO NOT DRILL ANY HOLES IN THE TOP OF THE DEVICE.

Installation of the probes

To achieve maximum performance from the advanced controller, correct installation of the probes is key as they are responsible for calculating the evaporator's thermal transfer coefficient, evaluating the start and end of the defrosts and diagnosing problems in the evaporator.

Material included

- One 4 mm hermetic evaporator probe, 1.5 m of cable.
- Two NTC probes, 1.5 m of cable
- Mounting clips for 10-13 / 14-18 / 19-21 / 22-25 mm coil

Location of the ambient probe

The probe should be located in a place that does not directly receive the flow of cold air from the evaporator. Preferably in its air aspiration area.

Location of the evaporator probe

The probe must be located as near as possible to the inlet of refrigerant from the evaporator (close to the expansion valve) in the finned area.

In certain evaporators, for example cubic ones, this inlet may be located on the front part of the battery, just behind the fan.

If defrost is done by electric heat, the probe must be located far away from them and, if possible, in the area of the evaporator where defrosting is slower, in other words, in the last area to defrost.

If the two conditions are not possible, the best possible compromise must be looked for.

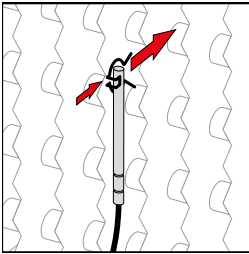

Select the appropriate clip depending on the size of its evaporator pipe.

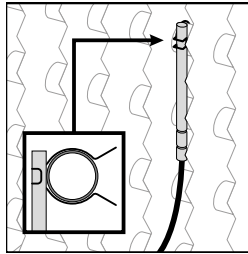

Attach the probe to the pipe using the clip, making sure that its end is in direct contact with the tube.

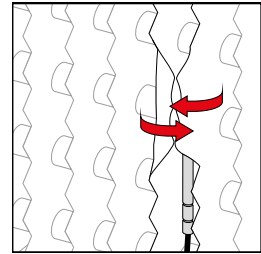

Bend the fins of both ends of the probe to increase the fixing and contact surface.

Initial configuration

The **AKO-16526A / AKO-16526AN** controller can be adapted to different types of installation according to the different options chosen in the set-up wizard.

Before completing the wiring, make sure you are familiar with the details of the installation in order to configure it correctly.

It is advisable to note the following points:

Compressor

Whether the controller should switch the compressor on and off (**Inl**= 2, 3, 5, 6, 7 or 8) or whether the compressor is switched on and off by the low pressure switch (**Inl**=1 or 4).

Defrost

Defrosting method used:

Electric (**Inl**= 1, 2 or 3)

Air (evaporator fans) (**Inl**= 4, 5 or 6)

Hot gas valve (Condensing unit) (**Inl**= 7 or 8)

Analogue outputs

The analogue output (ANALOG OUT) enables communication between the controller and the external controller of the electronic expansion valve (if **u00**=2) and can be configured as 4-20 mA output (**o30**=0) or as 0-10 V output (**o30**=1).

Consult the specifications of the external controller or drive before setting this option.

SET POINT (temperature)

Make a note of the desired set temperature value.

Type of gas

Type of gas used in the installation.

u02=0	R404A	u02=1	R134A	u02=2	R407A	u02=3	R407F	u02=4	R410A	u02=5	R450A
u02=6	R513A	u02=7	R744	u02=8	R449A	u02=9	R290	u02=10	R32	u02=11	R448A
u02=12	R1234ze	u02=13	R23	u02=14	R717	u02=15	R407C	u02=16	1234yf	u02=17	R22
u02=18	R454C	u02=19	R455A	u02=20	R507A	u02=21	R515B	u02=22	R452A	u02=23	R452B
u02=24	R454A										

Pressure sensor type

Type of evaporator pressure sensor installed:

4-20 mA (**I61**=1)

0-5 V (**I61**=2)

0.5-4.5 V (**I61**=3)

0-10 V (**I61**=4)

1-5 V (**I61**=5)

Note also the maximum and minimum values of the pressure sensor as well as the units of pressure used (bar or Psi).

Superheating SET POINT

Enter the desired optimum superheating value.

Assistant

The first time the unit receives the power supply, it will enter into ASSISTANT mode. The display will show the message **In1** flashing at **0**.



The buttons **▲** and **▼** change the value, the **SET** button accepts the value and moves on to the next step.



Step 1:

Select the most suitable In1 option based on the type of installation to be carried out and press **SET**.

The available options will be shown in the following table:

In1	Type of installation				Parameters											
	Control of the compressor	Pump Down	Defrost	Vent. Evap.	Pd	o00	o20	I00	I10	I11	I20	I21	d1	d7	F3	
0	Demo mode: it displays the temperature but does not regulate the temperature															
1	No	No	Electric	Yes	0	0	*	2	0	0	0	0	20	0	0	
2	Yes	Yes	Electric	Yes	1	1	*	2	7	1	0	0	20	0	0	
3	Yes	No	Electric	Yes	0	1	*	2	0	0	0	0	20	0	0	
4	No	No	Air	Yes	0	0	*	1	0	0	0	0	20	1	1	
5	Yes	Yes	Air	Yes	1	1	*	1	7	1	0	0	20	1	1	
6	Yes	No	Air	Yes	0	1	*	1	0	0	0	0	20	1	1	
7	Yes	Yes	Hot gas	Yes	1	1	*	2	7	1	7	1	5	2	0	
8	Yes	No	Hot gas	Yes	0	1	*	2	0	0	7	1	5	2	0	



If options 2, 5 or 7 are chosen, check the configuration of parameter I11 according to the pressure switch type used.

Step 2:

Define the type of refrigerant gas used.

u02=0	R404A	u02=1	R134A	u02=2	R407A
u02=3	R407F	u02=4	R410A	u02=5	R450A
u02=6	R513A	u02=7	R744	u02=8	R449A
u02=9	R290	u02=10	R32	u02=11	R448A
u02=12	R1234ze	u02=13	R23	u02=14	R717
u02=15	R407C	u02=16	R1234yf	u02=17	R22
u02=18	R454C	u02=19	R455A	u02=20	R507A
u02=21	R515B	u02=22	R452A	u02=23	R452B
u02=24	R454A				



▲ / ▼ / SET

Step 3*:

Define the minimum value of the pressure sensor (**I62**) (Value at 4 mA, 0 V, 0.5 V or 1 V according to **I61**).

Step 4*:

Define the maximum value of the pressure sensor (**I63**) (Value at 20 mA, 5 V, 4.5 V or 10 V according to **I61**).

*Steps only visible if u02=7

Step 5:

Select the temperature set point.

Step 6:

Set all other parameters to default?

dFP=0 No, the other parameters do not need to be changed.

dFP=1 Yes, set all other parameters to their default values.



This option only appears if this is not the first time the set-up wizard has been run.

The initial configuration is now complete, and the device will start to regulate the temperature.



The configuration wizard will not reactivate. To reactivate it, activate the stand-by mode (by pressing the m key for 3 seconds) and wait until the unit completely halts regulation (the m indicator will light up permanently) and press the ▲, ▼, SET buttons in this order in sequence, not at the same time.



If the Pump Down function is active, there may be a delay between the initiation of the Stand-by function and the moment the controller stops (See page 17).

Registration on akonet.cloud (only AKO-16525AN)

In order for the controller to be able to send operation data to akonet.cloud, it must be registered.

To do this, go to <https://akonet.cloud> (requires registration), click on "Add new device"  and continue with one of these two methods:

- Enter the serial number (S/N) and validation code / IMEI that appear on the tag and press "Search".
- Capture the QR code that appears on the tag using the  option (requires having a camera on your PC, tablet or mobile phone).

These data are found on the tag on the right hand side of the controller. More information can be found in the akonet.cloud user guide at: "<https://enhelpakonet.ako.com/>"

To access akonet.cloud, enter this address in your browser (the use of Google Chrome is recommended): <https://akonet.cloud>.



Before activating the device, make sure that there is enough reception at the installation location. **Activated devices may not be returned.**

Forcing transmission

When the steps of the configuration wizard and the registration process are completed in akonet.cloud, you must force a first transmission to verify the level of reception:

Press and hold the **ESC** and **SET** keys for 3 seconds.

After a moment, the display shows the quality of the NBloT signal received:

Low quality



Medium quality



High quality



Communication error



The controller does not start transmitting data to akonet.cloud until the first transmission is forced.

Operation

Messages

Pd

Pump down malfunction error (Stop). The time configured in parameter **C20** has been exceeded. Only displayed on screen.

LP

Pump down malfunction error (Start). The time configured in parameter **C19** has been exceeded. Only displayed on screen.

E1-EE

Sensor 1, 2, 3, 4, 5 or 6 is faulty (open circuit, crossed circuit, or value outside sensor limits). Activates the alarm relay and the audible alarm.

AdD

Open door alarm. Only if the door stays open for a longer time than defined in parameter **A12**. Activates the alarm relay and the audible alarm.

AH

Maximum temperature in control sensor alarm. The temperature value programmed in **A1** has been reached. Activates the alarm relay and the audible alarm.

AL

Minimum temperature in control sensor alarm. The temperature value programmed in **A2** has been reached. Activates the alarm relay and the audible alarm.

AE

External alarm activated (by digital input) . Activates the alarm relay and the audible alarm.

AES

Severe external alarm activated (by digital input). Activates the alarm relay and the audible alarm.

AdE

Defrost time-out alert. The time set in **d1** has been exceeded.

HCP

HACCP alarm. The temperature has reached the value of parameter **h1** for a longer period than established in **h2**. Activates the alarm relay and the audible alarm.

HPP

HACCP alarm due to a fault in the electric supply. The temperature set in **h1** has been reached following a fault in the electric supply. Activates the alarm relay and the audible alarm.

LSH

Minimum superheat alarm. The value set in **A20** has been reached. Activates the alarm relay and the audible alarm.

ASH

Minimum superheat alert. The value defined in **A23** has been reached. Only displayed on screen.

ADP

Maximum evaporating pressure alarm. The value defined in **A26** has been reached. Activates the alarm relay and the audible alarm.

LOP

Minimum evaporating pressure alarm. The value defined in **A29** has been reached (See page 27). Activates the alarm relay and the audible alarm.

DEF

Indicates that a defrost is being performed (See page 21). Only displayed on screen.

PAS

Password request. See parameters **b10** and **PAS** (See page 37). Only displayed on screen.

S1-S2

Shown sequentially with the temperature: The controller is in demo mode, the configuration has not been made.

CAL

Calibration ongoing, therefore, avoid, as far as possible, opening the cold room during the process. For more information, (See page 14).

E16

Flashing light with temperature: Configuration has been changed from 1 to 2 evaporators or vice versa.

SELFDRIIVE mode alert messages (Only shown by pressing the ▼ key)

E10/20

Defrost end error in 1/2 evaporator during the calibration, defrost has not ended due to temperature.

E11/21

Error during calibration in 1/2 evaporator. There is not enough difference in temperature between the cold room probe and the evaporator probe.

E12/22

It has not been possible to carry out the calibration due to a lack of stability in the system (Excessive door opening, excessive oscillations in the lower pressure, etc.).

E13/23

Error during normal operation (SELFDRIIVE Mode active) in 1/2 evaporator. There is not enough difference in temperature between the cold room probe and the evaporator probe.

E14/24

A lack of stability has been detected in the system (Excessive door opening, excessive oscillations in the low pressure, etc.) during normal operation (SELFDRIIVE Mode active).

E15/25

The persistent lack of stability has led to the deactivation of the SELFDRIIVE mode.

E17

Excessive door openings have been detected during calibration and it has not been possible to calibrate.

E18

Excessive door openings have been detected and the device cannot regulate in SELFDRIIVE mode.

SELFDRIVE mode



If the SELFDRIVE mode is activated (default configuration), the device periodically evaluates the evaporator's heat transfer, managing the available resources to maximise it.

The defrosts are minimised, adapting to the changing conditions of the cold room, reducing heat input into the refrigerated space, thermal stress in the evaporator and energy consumption.

Operation of the evaporate fans is optimised taking into account the compressor status, evaporate temperature, frost level, opening of the door, etc.

The control function of the drainage resistor minimises its activation (moments before starting a defrost), thereby reducing energy consumption.

To achieve correct operation of the SELFDRIVE mode, it is very important for the probes to be correctly installed, as described on page 8.

Calibration

During the first hours of operation, the device performs two calibrations automatically, during which the display shows the **CAL** message.



Calibration may take several hours and include several refrigeration and defrost cycles.



IMPORTANT:

During the calibration processes, the following should be avoided:

- Opening the cold room door
- Turning the controller off or putting it on stand-by
- Changing controller parameters, including the set point



While the calibration process is active:

- Manual defrost cannot be activated (⚡ key)
- The continuous cycle cannot be activated
- The set point change function cannot be activated

If calibration cannot be performed, or if an important part of the installation is replaced (compressor, evaporator, etc.) it is advisable to perform a manual calibration.

It is also recommended (not essential) to perform a manual calibration, once the installation has completed its commissioning, with a load inside it and when its operating temperature has been stabilised, after several days of operation, in this way calibration is optimal.

In the event of changing the set point or hysteresis, the device performs a calibration again automatically, except if the set point change is made using the "set point change mode" function (See page 19).

To perform a manual calibration, access the parameter menu (See page 32) and follow this sequence:

- Access parameter **b30**
- A security code is requested, enter code 63
- Using keys **▲** and **▼**, select option 1 and press **SET**

Cold regulation

Solenoid control (COOL Relay)

If **u00=1** is selected in the wizard, coolant production is regulated by controlling the opening and closing of the expansion valve (PWM control).

If **u00=2** is selected in the wizard, coolant production is regulated by controlling the opening degree of the expansion valve (stepper control). For more information on this type of regulation, please consult the [application note](#) available on our website.

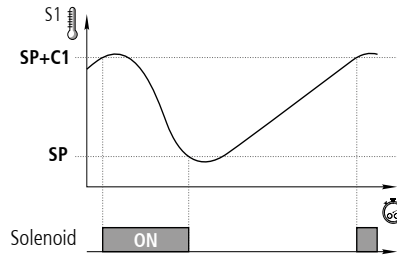

When the temperature in sensor S1 reaches the set point value (**SP**) plus the sensor differential (**C1**), coolant production is activated and the temperature drops. Once the set point (**SP**) value is reached, the solenoid closes.

Compressor control (Relay AUX 1)

With Pump Down (Inl: 2, 5, 7)

Requires the connection of a low pressure switch in digital input 1.

When the temperature in sensor S1 reaches the set point (**SP**) value plus the sensor's differential (**C1**), the solenoid opens, causing the pressure in the evaporator to increase and, therefore, the low pressure switch deactivates and the compressor starts up.

Once the set point (**SP**) value is reached, the solenoid closes, causing the pressure in the evaporator to decrease, triggering the low pressure switch and stopping the compressor.

For further details of the process, see the next page.

Without Pump Down (Inl: 3, 6, 8)

The compressor operates simultaneously with the solenoid valve, starting up when the latter opens and stopping when it closes.

Operation in the event of a fault in sensor S1

If sensor S1 fails (fault, disconnection, etc.), compressor behaviour will depend on parameter **C6**, with one of 3 options available:

C6=0: The compressor is stopped until sensor S1 begins to operate again.

C6=1: The compressor is started-up until sensor S1 begins to operate again

C6=2: The compressor operates in line with the average operation during the 24 hours prior to the error, taking into account the number of start-ups and stops and the average time in each state (stop-start). If 24 hours have not elapsed without a sensor error, the device moves to **C6=3** mode.

C6=3: The compressor operates according to the times programmed in **C7** (ON) and **C8** (OFF).

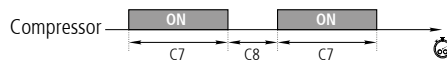

Control of superheating

Superheating (**SH**) is the temperature difference between the temperature at the evaporator outlet and the evaporating temperature. To obtain the SH value, sensors S5 (evaporator outlet temperature) and S6 (pressure sensor) are required. The pressure is converted to temperature according to the refrigerant gas used, so that the SH is obtained as:

$$SH (K) = \text{Temperature } S5 - \text{Temperature } S6$$

A low superheat allows for better evaporator efficiency, but too low a value may cause liquid to enter the compressors because the liquid in the evaporator is not completely evaporated.

The **AKO-16526A / AKO-16526AN** provides stable superheat regulation and a fast response to pressure or load fluctuations, thus ensuring a high level of system safety.



When the EEV is regulating, the cold icon on the display performs a dimming sequence, indicating that the expansion regulation is electronic and is therefore constantly being adjusted.

The superheat value is shown on the bottom line of the display by default. Parameter **b23** defines which value is displayed on that line.

When there is no cooling required, the superheat value is not updated, as the regulation is stopped. When the controller does not generate coolant, the display shows the last superheat value reached before cooling was required, for the user's information.



IMPORTANT

Install sensors S5 and S6 at the evaporator outlet.

The parameters must be set correctly in the set-up wizard to ensure correct regulation of superheating. Incorrect configuration can lead to problems in the refrigeration system.

Manual opening of the EEV valve

Using parameter **U11**, a fixed opening value can be set for the EEV valve. The equipment will perform ON/OFF cycles according to **U03** but always in line with the selected opening percentage.

This function should only be used by qualified personnel and in exceptional circumstances.

- Access parameter **U11**; the equipment will request a security code.
- Enter code 63
- Enter the opening percentage and press **SET**



The equipment will not readjust the valve opening until u11=-1 is configured again (manual opening disabled).

The valve will remain closed while there is no cold demand.

Pump down function

This function foresees problems in the compressor caused by movements of coolant, using a stop/start technique for the installation, controlled via the liquid solenoid, the low pressure switch and the compressor itself.

This function is only available for Inl 2, 5, and 7 and requires the connection of a low pressure switch in digital input 1. (**I10=7**)

STOP

When the temperature in sensor S1 reaches the set point (**SP**) value, the COOL relay deactivates, closing the solenoid valve.

Because the compressor continues to operate, pressure in the evaporator quickly drops. Upon reaching a given value, the low pressure switch activates, changing the status of digital input 1, which stops the compressor (relay AUX 1). This manoeuvre isolates all of the coolant in the high-pressure line, far from the compressor crankcase, preventing serious faults upon start-up.

Should the low pressure switch fail, the controller stops the compressor once the safety interval defined in **C20** has elapsed, displaying the message "**Pd**" (an informative message that does not affect the unit's operation).

If **C20** time is 0 (default value), the compressor will not stop until the low pressure switch is activated, but it will display the "**Pd**" message after 15 minutes.

START

When the temperature in sensor S1 reaches the set point value plus the differential (**SP+C1**), the COOL relay activates, opening the liquid solenoid. This increases the pressure in the evaporator, deactivating the low pressure switch, which turns the compressor on.

If, some time (determined by **C19**) after the liquid solenoid is opened (COOL relay set to ON), the low pressure switch does not deactivate, the controller will once again close the solenoid (COOL relay set to OFF) and the "**LP**" message will be displayed. This manoeuvre will be repeated every 2 minutes, indefinitely, until the pressure switch is deactivated and the installation reverts to its normal operation.

If **C19** time is 0 (default value), the solenoid will remain open until the low pressure switch deactivates, but it will display the "**LP**" message after 5 minutes.



STAND-BY

If the pump down function is active, there may be a delay between starting the stand-by function and the controller stopping; this is because certain installation control phases cannot be interrupted.

To force the stop of the controller, press the Stand-by key again for 3 seconds.

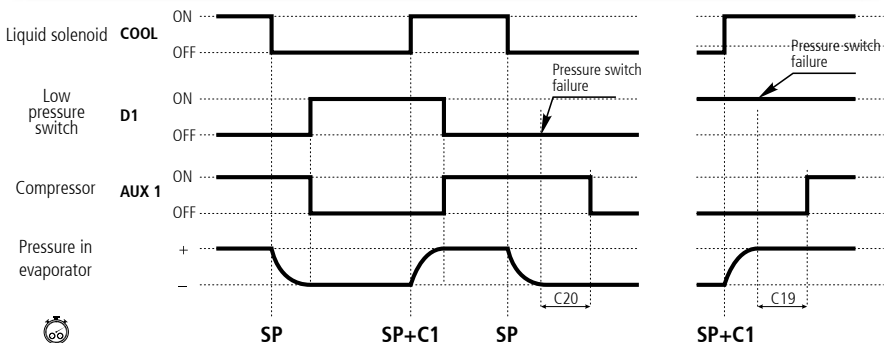

Regulation of cold with two temperature probes (S1 + S3)

This requires configuration of input D2/S4 as a second cold room store temperature probe (I20=11).

The device regulates the temperature of the cold room store taking into account the reading of both probes. Using parameter **C25**, the influence of probe S3 is determined in the settings.

Examples:	C25=0 (S1: 100% S3: 0%)	C25=75 (S1: 25% S3: 75%)
	C25=60 (S1: 40% S3: 60%)	C25=95 (S1: 5% S3: 95%)

This mode is particularly useful in large volume cold room stores, where there may be significant variations of temperature.

In the event of an error in probe 3 (E3), the controller only uses the reading of probe 1. If both probes break down (E1 + E3), the controller acts according to parameter **C6**.

Continuous cycle mode

This is used to quickly cool the cold room stores before products are loaded and is activated by pressing the  key for 3 seconds.

Upon activating this mode, the compressor begins to operate until the temperature in sensor S1 reaches the set point value, minus the variation indicated in parameter **C10**. The value of **C10** is always negative, unless it is 0.

The unit will immediately return to normal operation. Should it not be possible to reach this point, the device will return to normal operation once the time configured in **C9** has elapsed, or by pressing the  key again for 5 seconds.

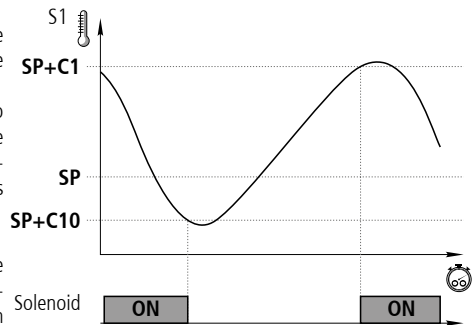

Calibration of sensor 1

Parameter **C0** allows for correction of the temperature detected by sensor 1; this is particularly useful when the sensor cannot be located in the ideal place.

Set Point locking

Parameters **C2** and **C3** allow for an upper and lower limit to be established for the set point (SP), to protect the product or installation from Set Point manipulation.

Product temperature

This function allows using a temperature probe to display the product temperature.

To activate it, input 2 must be configured as "Product temperature" (I20=9), and activate the display of probe 4 in the lower display (b23=3).

Set Point change mode

This allows for quick alternation between two working temperatures in the cold room store, modifying the Set Point in line with the value indicated in parameter **C12**. The aforementioned value may be negative or positive, which allows for the Set Point to be reduced or increased. If it is configured in 0, the mode is disabled.

It is activated in three possible ways:

- By means of an external switch connected to one of the digital inputs. The digital input should be configured as "Set Point change (**I10** or **I20**=4).
- By means of the CAMM module and the AKO CAMM tool application.

EXAMPLE:

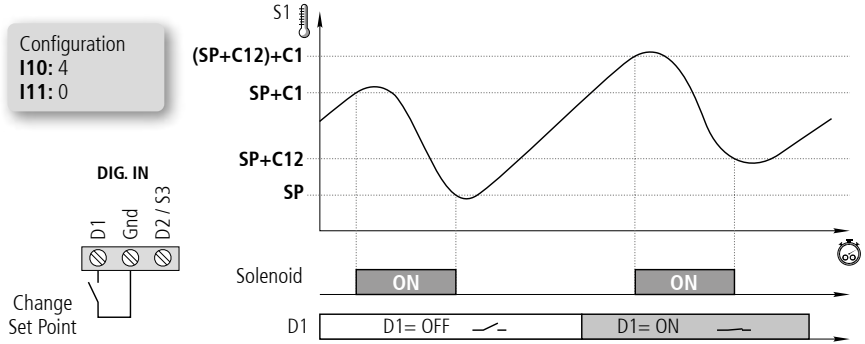

i If the SELFDRIIVE mode is active: It is recommended for calibration to be performed with the lowest set point value. It is recommended that the difference between set points is not greater than 5°C in negative cold room stores and 2°C in positive cold room stores.

Compressor protection timing

Parameter **C4** allows for selection of the type of timing to be applied to protect the compressor. These delays prevent continuous compressor starts and stops.

These timings affect the COOL and AUX 1 relays (if **o00**=1)

OFF-ON (C4=0): Minimum time in OFF mode before each start-up.

OFF-ON / ON-OFF (C4=1): Minimum time in ON and OFF mode for each cycle.

The delay time is defined by means of parameter **C5**; if **C5**=0, timing is disabled.

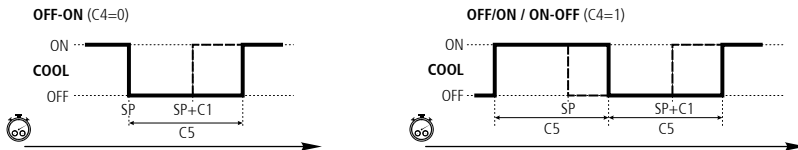

Door management

Standard operating mode (CE=0)

Door management allows for the installation's behaviour to be controlled, should the cold room door open through parameters **C22** and **C23**.

Parameter **C22** defines whether cold production should be stopped if the door opens. If **C22**=1, when the door opens, the fans stop and, 15 seconds later, the solenoid closes (COOL relay).

Parameter **C23** defines the maximum time, in minutes, that the installation can remain without producing cold whilst the door is open. If **C23**=0, cold is not produced with the door open.

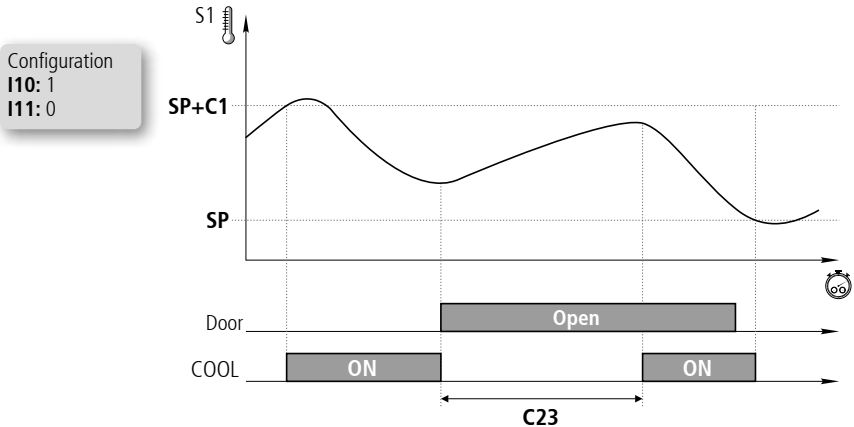

SELFDRIVE operating mode (CE=1)

If the SELFDRIVE mode is active, in the case of opening the door, the fans stop, or do not stop, depending on parameter **C22**. If the door does not close, when the time set in parameter **C24** has passed, cold production stops and does not activate again until the time set in **C23** has passed.

If, when the door is opened, cold is not being produced, only parameter **C23** is taken into account.

Management of door frame resistor

If the set point is equal to or below -4°C and the relay AUX 1, 2 or 3 has been configured as "door frame resistor" (**o00**, **o10**, **o20**=5), the resistor is activated (relay ON) when the temperature of the cold room store drops below -3°C , and is deactivated (relay OFF) when 0°C is reached.

Defrost

Types of defrost

There are 5 possible defrost types, depending on the option selected in the wizard (InI):

Electric (InI=1, 2 and 3) (d7=0)

Defrost is performed through electrical resistors, supplying the evaporator with heat. The operation of fans in this mode depends on parameter **F3**; the compressor and solenoid are stopped.

By air (InI=4, 5 and 6) (d7=1)

Usually used in positive cold rooms ($> 3^{\circ}\text{C}$), since the inside temperature of the cold room is sufficient to melt evaporator ice. By default, the fans are activated so that air may circulate through the evaporator; to stop them, change parameter **F3** to 0. The compressor and solenoid are stopped.

Hot gas (InI=7 and 8) (d7=2)

The hot gas from compressor discharge is used to melt evaporator ice and, to this end, two valves are necessary: one at the condenser input (A) and another between the compressor output and the evaporator input (B).

During the process, the liquid solenoid valve (C) and the condenser input valve (A) are closed and the evaporator input valve (B) is opened, forcing hot gas to pass through the latter, melting the ice.

Optionally, a high pressure switch (D) can be added to control the solenoid valve (digital input D2, **I20=7**) during the defrost process using hot gas. If the pressure decreases, the solenoid opens to allow liquid into the tank; when the pressure rises again, the solenoid closes.

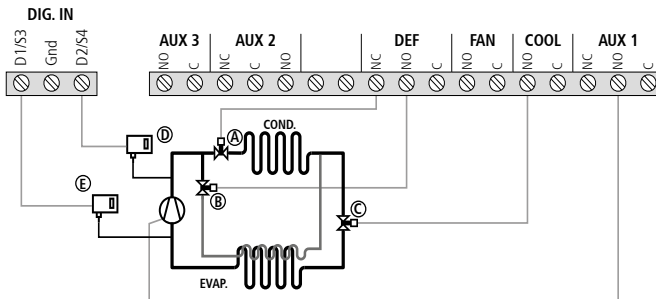

Control of defrost in standard mode (CE=0)

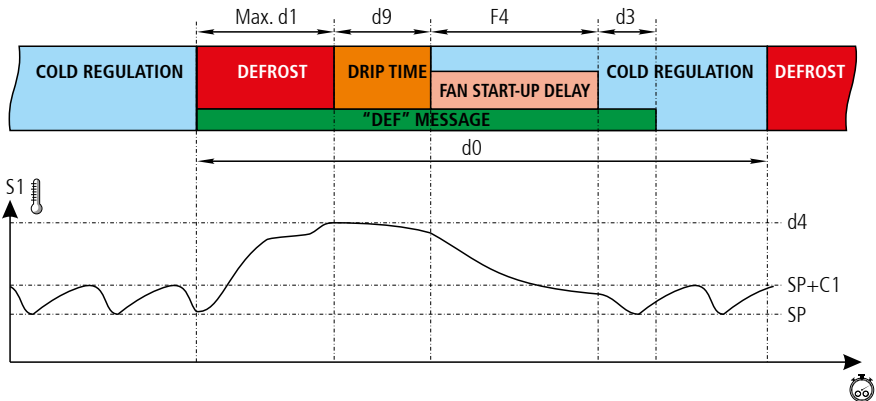
**Defrost start**

Defrost will start if:

- The time programmed in parameter **d0** has elapsed since the start of the last defrost.
- Press the **⌘** key for 3 seconds.
- By means of an external push-button (**I10 / I11=5**).
- Through the app or through AKONet.

Defrost completion

Defrost will complete if:

- The temperature programmed in parameter **d4** has been reached in sensor 2. This requires a 2nd sensor (**I00=2**) to be available, located in the evaporator.
- The time configured in parameter **d1** has elapsed (maximum defrost duration).
- Press the **⌘** key for 5 seconds.
- By means of an external push-button (**I10 / I20=5**).
- Through the app or through AKONet.

Control of defrost in SELFDRIVE mode (CE=1)

Defrosts in SELFDRIVE mode are not programmed, but rather the device evaluates the operation of the cold room and manages defrosts depending on the needs of the installation.

If a drop in the performance of the cold room is detected due to formation of ice in the evaporator, defrost is activated and it is supervised until its completion.

Using parameter **d30**, the defrost strategy is defined, a lower value allows less formation of frost in the evaporator, while a higher value acts with lower frequency allowing more frost to accumulate in the evaporator.

As a rule, a more aggressive strategy provides the system with greater efficiency allowing more frost to accumulate. Adapting the value of this parameter to the type of evaporator used and to the type of defrost configured according to the following table is recommended:

	TYPE OF DEFROST									
	ELECTRIC			AIR			HOT GAS			
	☼	☼☼	☼☼☼	☼	☼☼	☼☼☼	☼	☼☼	☼☼☼	
Fin spacing of the evaporator in mm	<3	0	1	2	1	3	4	0	1	2
	3.5	0	1	2	1	3	4	0	1	2
	4	1	2	3	2	4	5	0	1	2
	4.5	2	3	4	3	5	6	1	2	3
	5	2	3	5	3	5	7	1	2	3
	5.5	2	3	5	3	5	7	1	2	4
	6	3	4	6	4	6	8	1	3	4
	6.5	3	4	6	4	6	8	1	3	4
	7	4	5	7	4	7	9	2	3	4
	7.5	4	6	7	5	8	9	2	3	4
	8	4	6	8	5	8	10	3	4	5
	8.5	5	7	8	6	9	10	3	4	5
	9	5	7	8	6	9	10	4	5	6
	9.5	5	8	9	6	10	10	4	5	6
	10	6	8	9	7	10	10	4	5	6
10.5	6	8	10	7	10	10	4	5	6	
>11	6	9	10	7	10	10	4	5	6	

Strategy: ☼ Conservative ☼☼ Moderate ☼☼☼ Aggressive

Parameter **d31** allows establishing a time limit without making defrosts, if the cold room does not require defrosts set it to 0, if the cold room can generate frost it is recommended to set a security time of between 2 and 7 days.

Parameter **d32** defines the maximum time permitted of the cold room without reaching the Set Point, after which an emergency defrost starts to unlock the evaporator.

Parameter **d4** defines the final defrost temperature.



It is advisable to configure all the parameters relating to defrost since, in the event of a calibration or operating error of the SELFDRIVE mode, the controller then temporarily regulates in standard mode.

Other defrost parameters (They have an effect in standard and SELFDRIVE mode)

Drip time

It is set by parameter **d9** and defines the time added at the end of defrost to allow the evacuation of the remaining defrost water from the evaporator, during which time there is no cooling regulation.

Fan start-up delay

This is established through parameter **F4** and allows for the possible drops left in the evaporator to freeze before the fans activate, preventing them from being projected into the cold room. It also prevents heat being supplied to the cold room due to defrost in the evaporator.



If defrost is cancelled before 1 minute has elapsed, the drip time (**d9**) is not applied and the fans are activated without taking into account the start-up delay (**F4**).

If defrost is by air or is static, the drip time (**d9**) and fan start-up delay (**F4**) are deactivated.

Message displayed during defrost

This is established using parameter **d2**, and you can choose between displaying the real temperature captured by sensor 1 (**d2=0**), showing the temperature captured by sensor 1 at the start of the defrost (**d2=1**), or displaying the dEF (**d2=2**) message. Parameter **d3** defines the time during which the aforementioned message will be displayed once the drip time (**d9**) and fan stop time (**F4**) are complete.

Remote defrost

This function allows defrost of the unit to be activated using an external key, connecting it to one of the digital inputs that must be configured as remote defrost (**I10** or **I20=5**).

Defrost locking

This prevents defrost starting at unusual points by means of an external switch, which may be useful for ensuring that the installation's load does not excessively increase, exceeding the permitted limits.

The external switch must be connected to one of the digital inputs, which should be configured as "Defrost locking" (**I10** or **I20=6**).

Defrosting in a second evaporator

This function allows for defrost to be controlled in a second evaporator, provided that defrost is by electric heat, by air or is static. The same type of defrost should be used for the first and second evaporators.

This requires configuration of input D2/S4 as a 2nd evaporator sensor (**I20=10**). In the event of an error in the 2nd evaporator sensor, defrost completes once the time defined in **d1** has elapsed.

Electric defrosting

This requires configuration of relay AUX 2 as 2nd evaporator defrost (**o10=4**). Defrost begins simultaneously in both evaporators. When the sensor of evaporator 1 reaches the temperature defined in **d4**, the DEF relay deactivates, completing defrost of evaporator 1. Defrost of evaporator 2 is completed when the evaporator 2 sensor reaches the temperature defined in **d4**. Drip time begins when both defrosts are complete.

Defrost by air

The fans of both evaporators are connected in parallel to the FAN relay. Defrost begins simultaneously in both evaporators and does not complete until both probes reach the temperature defined in **d4**. Drip time subsequently begins.

Static defrost

Defrost begins simultaneously in both evaporators and does not complete until both probes reach the temperature defined in **d4**. Drip time subsequently begins.

Other parameters

Using parameter **d5**, you can configure whether the unit performs a defrost (**d5=1**) or not (**d5=0**) when it receives power (first start-up or after a power supply failure). Should the option YES (**d5=1**) be selected, defrost will begin once the delay time defined in **d6** has elapsed.

Using parameter **d8**, we define the time tally established in **d0**, choosing between total time elapsed (**d8=0**) or the sum of compressor operation time (**d8=1**).

i **REMARK:** If parameter **d1** is configured to 0, no defrosts are performed.

Management of the drainage resistor

Activates the drainage resistor before the start of defrost and deactivates it one hour after finishing, avoiding unnecessary energy consumption in the absence of defrosts. For this function to be active, one of the auxiliary relays (AUX 1, 2 or 3) must be configured as 'Drain resistor' (o00=6, o10=8 or o20=10).

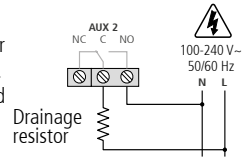

Evaporator fans

Control of fans in standard mode (CE=0)

Fans are controlled through sensor 2 (evaporator) and parameters **F0** (stop temperature) and **F1** (sensor differential). If sensor S2 is not connected or an error in the sensor (E2) is detected, the fans continuously operate without taking into account parameters **F0** and **F1**, but taking the remaining parameters (**F2** to **F4**) into account.

Using parameter **F2**, the status of the fans during compressor stops is defined.

Using parameter **F3**, the status of the fans during defrost is defined.

Parameter **F4** defines the fan start-up delay time after defrost (See page 21).

Parameter **C22** defines whether fans stop when the door is opened.

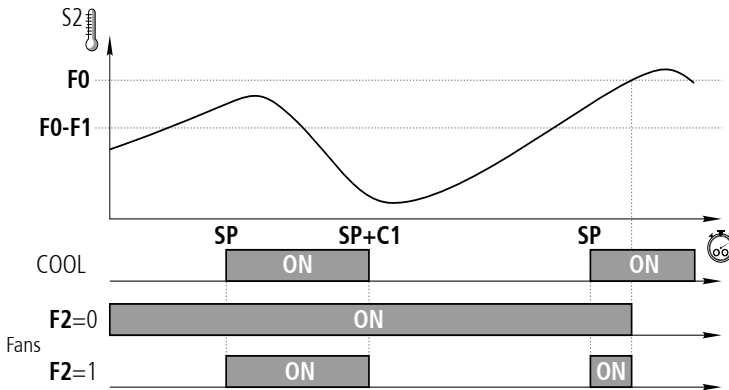

Control of fans in SELFDRIIVE mode (CE=1)

With the SELFDRIIVE mode active, fan control is performed taking into account the evaporator temperature, compressor, frost level, the cold room temperature and if the door is open or not, optimising its operation. In this way its operation is optimised to obtain the greatest energy efficiency of the cold room.

With this mode active, only parameters **F0**, **F1** and **F4** need to be configured.

i It is advisable to configure all parameters relating to the fans since, in the event of a calibration or operating error of the SELFDRIIVE mode, the controller then temporarily regulates in standard mode.

Alarms

The device warns the user through an on-screen message as to activation of a relay (if a relay has been set as an alarm) and a sound alarm when the criteria programmed in the parameters are met.

Maximum / minimum temperature alarm

It shows the message "RH" or "RL" when the temperature in sensor 1 reaches the value configured in parameters **A1** (maximum temperature) and **A2** (minimum temperature).



This value may be:

- **Absolute (A0=1):** The temperature at which the alarm should activate must be indicated in A1/A2.
- **Relative to the SP (A0=0):** The increase or decrease in the number of degrees necessary for the alarm to activate, in relation to the set point, must be indicated in A1/A2. This option enables us to change the set point without having to reset the maximum and minimum alarms.

Parameter A10 establishes the differential of both parameters (Hysteresis).



Example

We configure the following parameters in a controller: SP=2, A1=10, A10=2

- If A0=0 (Relative to the SP), the maximum temperature alarm will activate when 12 degrees are reached in sensor 1, and will deactivate when 10 degrees are reached.
- If A0=1 (Absolute), the maximum temperature alarm will activate when 10 degrees are reached in sensor 1, and will deactivate when 8 degrees are reached.

External alarm / severe external alarm

The message **RE** (External alarm) or **RES** (Severe external alarm) is displayed when the digital input configured as external alarm or severe external alarm is activated.



The severe external alarm also deactivates all the loads and, therefore, temperature regulation stops. When this alarm disappears, the device returns to its normal operation.

At least one of the digital inputs must be configured as an external alarm (**I10** or **I20=2**) or as a severe external alarm (**I10** or **I20=2**).

Evaporator sensor error alarm due to moisture ingress

If, at the start of defrost, the temperature in sensor S2 is 20°C higher than the temperature in sensor S1, the defrost ignores sensor S2 and completes due to time-out.



The display shows the message **E2**, activates the alarm relay and audible alarm.

The alarm can be silenced, but alarm icon Δ will not disappear until:

- The controller is switched off and then on again.
- Defrost without error is started in sensor S2.

If the 2nd evaporator sensor (**I20=10**) has been enabled, it will behave in the same way, but displaying the message **E3**.

HACCP alarm

The alarm is activated should situations be detected which could endanger the integrity of the products stored in the cold room.

If the temperature of the cold room is higher than that defined in parameter **h1** for a length of time exceeding that defined in parameter **h2**, the alarm activates, displaying the message **HCP** on screen.

Upon pressing the mute key, the sound alarm switches off, but the alarm remains.

Once the temperature drops below parameter **h1**, if the mute key has been pressed, the alarm disappears. If the mute key has not been pressed, the audible alarm deactivates but the HACCP indicator remains in flashing mode, indicating that a non-confirmed HACCP alarm has occurred.

Press the mute key to confirm an HACCP alarm.

Sensor error alarm

If one of the enabled probes is crossed, open circuit, or out of range, the message E1, E2, E3, E4, E5 or E6 is displayed depending on whether it is sensor S1, S2, S3, S4, S5 or S6.

Open door alarm

The door has been open for a longer time than defined in parameter **A12**, the open door alarm is activated.

In order to detect the open door, configuration is required of one of the digital inputs as "door contact" (**I10** or **I20=1**).

Activates alarm relay and audible alarm.

Minimum superheat alarm

If the superheat value falls below the value defined in parameter **A20**, the alarm is activated and the display shows the message **L5H**.

The alarm disappears when the value **A20** + differential **A22** is reached.

Parameter **A21** allows a delay in the activation of this alarm to be defined.

Activates the alarm relay and the audible alarm.

Maximum evaporating pressure alarm

If the evaporating pressure exceeds the value defined in parameter **A26**, the alarm is activated and the display shows the message **ROP**.

The alarm disappears when the value **A26** + differential **A28** is reached.

Parameter **A27** allows a delay in the activation of this alarm to be defined.

Activates the alarm relay and the audible alarm.

Minimum evaporating pressure alarm

If the evaporating pressure falls below the value defined in parameter **r**, the alarm is activated and the display shows the message **LOP**.

The alarm disappears when the value **A29** - **A31** is reached.

Parameter **A30** allows a delay in the activation of this alarm to be defined.

Activates the alarm relay and the audible alarm.

Alarm delays

These delays prevent certain alarms from being shown, to allow the installation to recover its normal operation after certain events.

- Delays in start-up (**A3**): This delays the activation of the temperature alarms upon receiving power (at start-up or after a power supply failure) or when exiting Stand-by mode. This allows for the installation to start up avoiding alarms.
- Delay after a defrost (**A4**): This delays the activation of the temperature alarms when a defrost completes.
- Maximum and minimum temperature alarm delay (**A5**): This delays the activation of the maximum (A1) and minimum (**A2**) temperature alarms, from when the temperature in sensor 1 reaches the programmed value.
- Delay to activation of external alarm (**A6**): This delays the activation of the external alarm, from when the digital input becomes active.
- Delay to deactivation of external alarm (**A7**): This delays the deactivation of the external alarm, from when the digital input becomes active.
- Delay to activation of open door alarm (**A12**): Delays activation of the open door alarm.
- Delay to activation of **L5H** alarm (**A21**): Delays activation of the low superheat alarm from when the programmed value is reached.
- Delay to activation of **HP** alarm (**A26**): Delays activation of the maximum operating pressure alarm from when the programmed value is reached.
- Delay to activation of **LP** alarm (**A30**): Delays activation of the lowest operating pressure alarm from when the programmed value is reached.

Alarm relay configuration

Should any relay have been configured as an alarm relay, parameter **A9** allows for the relay status to be defined when an alarm is triggered:

A9=0 Relay active (ON) in the event of an alarm (OFF without alarm)

A9=1 Relay inactive (OFF) in the event of an alarm (ON without alarm)

Alerts

The device alerts the user through an on-screen message when an event occurs which requires his/her attention. However, it does not activate the sound alarm or the alarm relay (if active).

Defrost time-out alert

The message **Adt** is displayed when a defrost has completed due to time-out, if parameter **A8=1**.

Pump down malfunction error (stop)

The message **Pd** is displayed if a malfunction is detected when the installation is stopped using the pump down manoeuvre. (See page 17).

Pump down malfunction error (start-up)

Displays the **LP** message if a malfunction is detected when the installation is started up using the pump down manoeuvre. (See page 17).

Maximum overheating alert

If the superheat value falls below the value defined in parameter **A23**, the and the display shows the message **H5H**.

The alert disappears when the value **A23 - A25** is reached.

Parameter **A23** allows a delay in the activation of this alarm to be defined.

Light control

Relay AUX 1 or AUX 2 must be configured as "Light" (**o00**, **o10** or **o20=2**).

Switching the lights on or off is controlled using:

- The  **push-button**: One press switches the lights on or off.
- **The cold room door**: When the door is opened, the lights remain on for the time defined by parameter **b01**. If the value is 0, when the door closes the lights go out. (One of the digital inputs must be configured as door contact (**I10** or **I20=1**). The control even occurs with the equipment in Stand-by.

Password

Allows the configuration of the equipment to be protected by a 2-digit code.

If it is active a code is requested when you try to access the programming menu. This menu cannot

be accessed if a wrong value is entered. The code is set via the **PAS** parameter. Parameter **b10** defines the operation of this code.



Remote Stand-by mode

This allows activating Stand-by mode using a switch connected to one of the digital inputs.

Said digital input must be set to Stand-by remote activation (**I10=8** or **I20=8**).

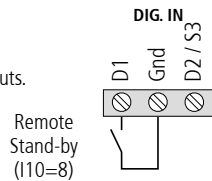

Operation of the auxiliary relays

Depending on the controller model, it may have 1 or 2 auxiliary relays. The function of these relays is configurable via the parameter menu.

AUX 1 relay

- **Deactivated (o00=0)**: Does not carry out any function.
- **Compressors / crankcase resistor (o00=1)**: Controls compressor operation. When the compressor is not in operation, it powers the crankcase resistor. This function can only be selected via the initial wizard (**ini**).
- **Light (o00=2)**: This regulates the operation of cold room light.
- **Virtual control (o00=3)**: The relay can be remotely activated and deactivated by means of AKONet software.
- **Alarm (o00=4)**: This activates the relay every time that an alarm occurs (See page 26).
- **Door frame resistor (o00=5)**: This controls the operation of the cold room's door frame resistor (See page 20).
- **Drainage resistor (o00=6)**: Controls the activation/deactivation of the evaporator drainage resistor (See page 25).

AUX 2 relay

- **Deactivated (o10=0)**: Does not carry out any function.
- **Alarm (o10=1)**: This activates the relay every time that an alarm occurs (See page 26).
- **Light (o10=2)**: This regulates the operation of cold room light.
- **Virtual control (o10=3)**: The relay can be remotely activated and deactivated by means of AKONet software.
- **Defrost 2nd Evaporator (o10=4)**: This controls the defrost resistors of a second evaporator (See page 24).
- **Door frame resistor (o10=5)**: This controls the operation of the cold room's door frame resistor (See page 20).
- **Same as solenoid status (o10=6)**: Imitates solenoid status: active if the solenoid is in ON mode, inactive if the solenoid is in OFF mode.
- **Same as unit status (o10=7)**: Indicates the unit's status: active if the unit is in ON mode, inactive if the unit is in Stand-by mode.
- **Drainage resistor (o10=8)**: Controls the activation/deactivation of the evaporator drainage resistor (See page 25).

AUX 3 relay

- **Deactivated (o20=0):** Does not carry out any function.
- **Alarm (o20=1):** This activates the relay every time an alarm occurs (See page 26).
- **Light (o20=2):** This regulates the operation of cold room light.
- **ON/OFF external control (o20=3):** Sends the ON/OFF signal to the EVV driver.
- **Defrost 2nd Evaporator (o20=4):** This controls the defrost resistors of a second evaporator (See page 24).
- **Door frame resistor (o20=5):** This controls the operation of the cold room's door frame resistor (See page 20).
- **Drainage resistor (o20=6):** Controls the activation/deactivation of the evaporator drainage resistor (See page 25).

Configuration

Condensed programming menu

This allows for the most-used parameters to be quickly configured. Press the **SET** key for 3 seconds to access it.

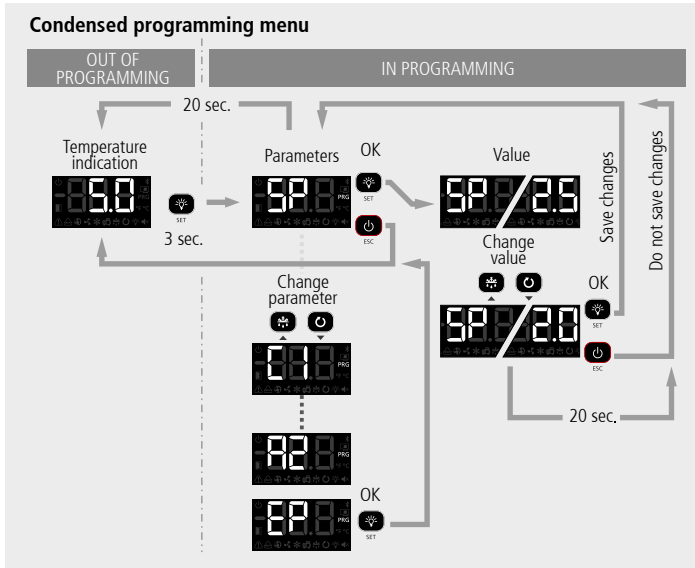

Parameters

Level 2	Description	Values	Min.	Def.	Max.
SP	Temperature setting (Set Point)	°C/°F	-50	0.0	99
CE	SELFDRIIVE Mode 0=Deactivated 1= Activated		0	0	1
C1	Sensor 1 differential (Hysteresis)	°C/°F	1.0	2.0	20.0
d0	Defrost frequency (time between 2 starts)	h.	0	6	96
d1	Maximum defrost duration (0=defrost deactivated)	min.	0	*	255
d4	Final defrost temperature (by sensor) (If I00 ≠ 1)	°C/°F	0	8.0	50
SH	Superheating set point	°K	0.1	8	40
F3	Status of the fans during the defrost 0=Stopped; 1=Running		0	*	1
A1	Alarm for maximum in sensor 1 (it must be higher than the SP)	°C/°F	A2	99.0	99.0
A2	Alarm for minimum in sensor 1 (it must be lower than the SP)	°C/°F	-50	-50	A1
d30	Defrost strategy in SELFDRIIVE mode		0	5	10

* According to the set-up wizard.

Extended programming menu

Use the extended programming menu to configure all of the unit's parameters in order to adapt it to your installation requirements. Press the **SET** key for 6 seconds to access it.

i **IMPORTANT:** If the password function has been configured as a keypad lock (**b10=2**), or as an access to parameters block (**b10=1**), you will be requested to enter the password programmed in **PAS** when attempting to access either of the two functions. If the entered password is not correct, the unit will go back to showing the temperature.

i **IMPORTANT:** Certain parameters or menus may not be visible depending on the configuration of the other parameters and the options chosen during set-up.

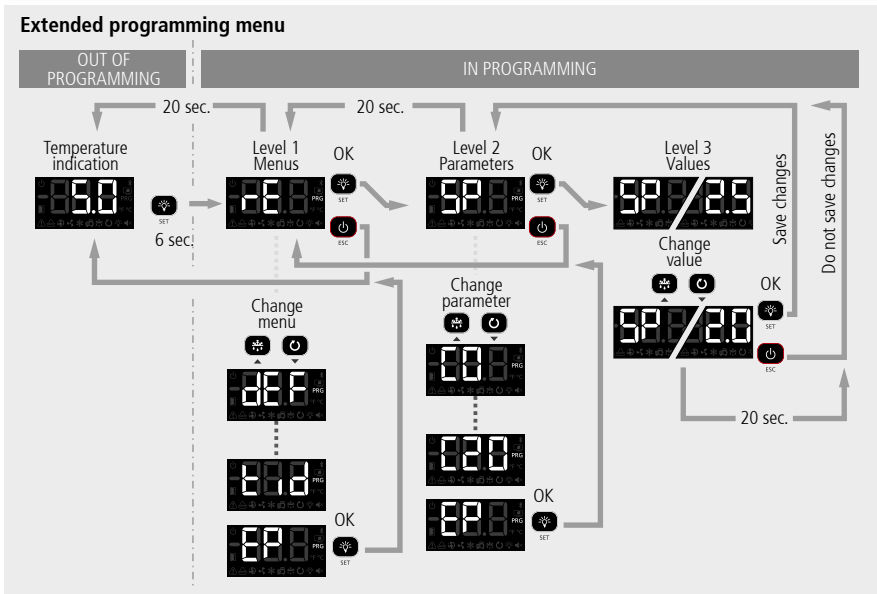

Parameters

Regulation and control

Level 1	Level 2	Description	Values	Min.	Def.	Max.
	SP	Temperature setting (Set Point)	°C/°F	-50	0.0	99
	CE	SELFDRIIVE Mode 0=Deactivated 1= Activated		0	1	1
	C0	Sensor 1 calibration (Offset)	°C/°F	-4.0	0.0	4.0
	C1	Sensor 1 differential (Hysteresis)	°C/°F	1.0	2.0	20.0
	C2	Set point top locking (it cannot be set above this value)	°C/°F	C3	99	99
	C3	Set point bottom locking (it cannot be set under this value)	°C/°F	-50	-50	C2
	C4	Type of delay for the protection of the compressor: 0=Minimum OFF time of the compressor 1=Minimum OFF and ON time of the compressor in each cycle		0	0	1
	C5	Protection delay time (Value of the option selected in parameter C4)	min.	0	0	120
	C6	COOL relay status with fault in sensor 1: 0=OFF; 1=ON; 2=Average according to last 24 h before the sensor error; 3=ON-OFF according prog. C7 and C8		0	2	3
	C7	Time of relay ON if sensor 1 damaged (If C7=0 and C8≠0, the relay will always be OFF when disconnected)	min.	0	10	120
	C8	Time of relay OFF if sensor 1 damaged (If C8=0 and C7≠0, the relay will always be ON when connected)	min.	0	5	120
	C9	Maximum duration of the continuous cycle mode. (0=deactivated)	h.	0	0	48
	C10	Variation of the Set Point (SP) in continuous cycle mode. When it reaches this point (SP+C10), it reverts to the normal mode. (SP+C10 ≥ C3). The value of this parameter is always negative, unless it is 0. (0=OFF)	°C/°F	0	-50	C3-SP
	C12	Variation of the set point (SP) when the change set point change function is active. (SP+C12 ≤ C2) (0= deactivated)	°C/°F	C3-SP	0	C2-SP
	C19	Maximum time for start-up after gas collection (Values between 1 and 9 seconds are not accepted) (0= Deactivated)	sec.	0	0	120
	C20	Maximum time for pump down (0= deactivated)	min.	0	0	15
	C22	Stop fans and COOL when opening door 0=No 1=Yes		0	0	1
	C23	Start-up delay for fans and COOL when door open	min.	0	0	999
	C24	Delay time of cold stop with door open.	sec.	0	0	C23
	C25	Influence of probe S3 when regulating with two temperature probes (I20=11) (See page 18)	%	0	0	95
	C27	Sensor 4 calibration (Offset)	°C/°F	-4.0	0.0	4.0
	EP	Output to level 1				

Defrost

Level 1	Level 2	Description	Values	Min.	Def.	Max.
DEF	d0	Defrost frequency (time between 2 starts)	h.	0	6	96
	d1	Maximum defrost duration (0=defrost deactivated)	min.	0	*	255
	d2	Type of message during the defrost: 0=Sign of the real temperature; 1=Sign of the temperature at the start of the defrost; 2=Sample of the dEF message		0	2	2
	d3	Maximum message duration (Time added at the end of the defrost process)	min.	0	5	255
	d4	Final defrost temperature (by sensor) (If I00 ≠ 1)	°C/°F	0	8.0	50
	d5	Defrost on connecting the unit: 0=NO, First defrost according to d0; 1=YES, First defrost according to d6		0	0	1
	d6	Delay of the defrost start on connecting the unit	min.	0	0	255
	d7	Type of defrost: 0=Resistors; 1=Air / fans; 2=Hot gas		0	*	2
	d8	Time calculation between defrost periods: 0=Total real time 1=Sum of COOL time connected		0	0	1
	d9	Drip time when a defrost finishes (Stop COOL and fans)	min.	0	1	255
	d30	Defrost strategy in SELFDRIVE mode (See page 23)		0	5	10
	d31	Maximum time without defrosting (0=Deactivated)	h.	0	96	999
	d32	Maximum time of cold room outside the temperature regulation range (0=Deactivated)	h.	0	2	10
	EP	Output to level 1				

Evaporator fans

Level 1	Level 2	Description	Values	Min.	Def.	Max.
FAN	F0	Fans stop temperature	°C/°F.	-50	45	50
	F1	Sensor 2 differential if fans are stopped	°C/°F	0.1	2.0	20.0
	F2	Stop fans when the compressor stops 0=No 1=Yes		0	0	1
	F3	Status of the fans during the defrost 0=Stopped; 1=Running		0	*	1
	F4	Start-up delay after defrost (if F3=0) Only actuates if higher than d9	min.	0	2	99
	EP	Output to level 1				

* According to the set-up wizard.

Expansion valve

Level 1	Level 2	Description	Values	Min.	Def.	Max.
EEV	u00	Valve type: 1=PWM-type EEV 2=Stepper-type EEV		1	1	2
	SH	Superheating set point	K	0.1	8	40
	u02	Refrigerant gas type: 0= R-404A, 1= R-134A, 2= R-407A, 3= R-407F, 4= R-410A, 5= R-450A, 6= R-513A, 7= R-744, 8= R-449A, 9= R-290, 10= R-32, 11= R-448A, 12=R1234ze, 13=R23, 14=R717, 15=R407C, 16=R1234yf, 17=R22, 18=R454C, 19=R455A, 20=R507A, 21=R515B, 22=R452A, 23=R452B, 24=R454A		0	*	24
	u03	PWM cycle time	s.	2	6	10
	u04	Proportional constant value (P)		1	10	100
	u05	Integral constant value (I)		0	10	100
	u06	Derivative constant value (D)		0	0	100
	u07	Opening value of the electronic expansion valve when cooling is activated	%	u13	50	u12
	u08	Duration of valve opening on cooling demand	s.	2	5	240
	u09	Valve opening value with sensor error S5 or S6: 0=Fixed opening according to u10; 1=Average opening over the last 24 hours		0	0	1
	u10	Valve opening value with sensor error S5 or S6 (if u09=0)	%	u13	0	u12
	u11	Manual valve opening value (-1=Disabled), (cycles acc. to u03) (See page 16)	%	-1	-1	100
	u12	Maximum valve opening value	%	u13	100	100
	u13	Minimum valve opening value	%	0	0	u12
	u14	Valve opening value after defrost (0=Disabled), (duration according to u15)	%	0/ u13	0	u12
	u15	Duration of valve opening after defrosting	s	0	0	240
u16	Valve opening in case of LOP error (0=valve closed)	%	0/ u13	0	u12	
EP	Output to level 1					

* According to the set-up wizard.

Alarms

Level 1	Level 2	Description	Values	Min.	Def.	Max.
	A0	Configuration of the temperature alarms 0=Relative to SP 1=Absolute		0	1	1
	A1	Alarm for maximum in sensor 1 (it must be higher than the SP)	°C/°F	A2	99.0	99.0
	A2	Alarm for minimum in sensor 1 (it must be lower than the SP)	°C/°F	-50	-50	A1
	A3	Delay of temperature alarms in the start-up	min.	0	0	120
	A4	Delay of temperature alarms from the end of a defrost	min.	0	0	99
	A5	Delay of temperature alarms from when the A1 or A2 value is reached	min.	0	30	99
	A6	Delay of external alarm/severe external alarm on receiving digital input signal (I10 or I20=2 or 3)	min.	0	0	120
	A7	External alarm deactivation delay / Severe external alarm on disappearance of signal at digital input (I10 or I20=2 or 3)	min.	0	0	120
	A8	Show warning if the defrost ends for maximum time 0=No 1=Yes		0	0	1
	A9	Polarity relay alarm 0= Relay ON in alarm (OFF without alarm); 1= Relay OFF in alarm (ON without alarm)		0	0	1
	A10	Differential of temperature alarms (A1 and A2)	°C/°F	0.1	1.0	20.0
	A12	Delay of open door alarm (if I10 or I20=1)	min.	0	10	120
	A20	Minimum superheating value for LSH alarm	K	0	2	SH
AL	A21	LSH alarm activation delay	sec.	0	30	240
	A22	LSH alarm hysteresis	K	0.1	2	Sh-A20
	A23	Maximum superheating value for HSH warning	K	sh	40	40
	A24	Delayed activation of the HSH warning	s	0	30	240
	A25	HSH alarm deactivation hysteresis	K	0.1	2	A23-sh
	A26	Maximum evaporating pressure (MOP)	bar	0	60	60
	A27	MOP alarm activation delay (Delay time for activating alarm after threshold has been exceeded)	sec.	0	30	240
	A28	MOP alarm deactivation hysteresis (When the pressure drops below the MOP-hysteresis level the alarm is deactivated)	bar	0.1	1	60
	A29	Minimum evaporating pressure (LOP)	bar	-1	0	8
	A30	LOP alarm activation delay (Delay time for activating alarm after threshold has been exceeded)	sec.	0	30	240
	A31	LOP alarm deactivation hysteresis (When the pressure exceeds the LOP+hysteresis level the alarm is deactivated)	bar	0.1	1	8
	EP	Output to level 1				

Basic configuration

Level 1	Level 2	Description	Values	Min.	Def.	Max.
bcn	b00	Delay of all functions on receiving power supply	min.	0	0	255
	b01	Cold room light timing	min.	0	0	999
	b10	Password function 0=Inactive 1=Block access to parameters 2=Lock keypad		0	0	2
	PAS	Password		0	0	99
	b20	MODBUS address		1	1	247
	b21	Communication speed: 0=9600 bps 1=19200 bps 2=38400 bps 3=57600 bps	bps	0	0	3
	b22	Audible alarm enabled 0= No 1=Yes		0	1	1
	b23	Lower display function: 1=sensor S2, 2=sensor S3, 3=sensor S4, 4=sensor S5, 5=Superheating, 6=Pressure sensor, 7=% EEV, 9=Carousel, 10 = Off		1	*	10
	b30	Activation of manual calibration 0=Deactivated 1= Activated Requires security code, (See page 14)		0	0	1
	Unt	Working units 0=°C 1=°F		0	0	1
EP	Output to level 1					

Inputs and outputs

Level 1	Level 2	Description	Values	Min.	Def.	Max.
InO	St	Type of probes connected: 0= NTC, 1= Pt1000		0	0	1
	I00	Probes connected: 1=Sensor 1 (cold room), 2=Sensor 1 (cold room) + Sensor 2 (evaporator)		1	2	2
	I10	D1 / S3 input configuration: 0=Deactivated, 1=Door contact, 2=External alarm, 3=Severe external alarm, 4=Change SP, 5=Remote defrost, 6=Defrost lockout, 7=Low pressure switch, 8=Remote activation in standby mode, 9=Product temperature		0	*	9
	I11	Digital input polarity D1: 0=Activates on closing, 1=Activates on opening contact		0	0	1
	I20	D2 / S4 input configuration: 0=Deactivated, 1=Door contact, 2=External alarm, 3=Severe external alarm, 4=Change SP, 5=Remote defrost, 6=Defrost lockout, 7=High pressure switch for hot gas, 8=Remote activation of standby mode, 9=Product temperature, 10=Defrost 2nd evaporator, 11=2nd cold room temperature probe		0	*	11
	I21	Digital input polarity D2: 0=Activates on closing, 1=Activates on opening contact		0	0	1
	I60	Pressure units: 0= bar, 1= Psi		0	*	1
	I61	Pressure sensor type (S6): 0= Deactivated, 1= 4-20 mA, 2= 0-5 V, 3= 0.5-4.5 V, 4= 0-10 V, 5= 1-5 V		0	0	5
	I62	Minimum pressure sensor value (4mA, 0V, 0.5V, 1)		-1	0	163
	I63	Maximum pressure sensor value (20mA, 5V, 4.5V, 10V)		162	12	60
I64	Pressure sensor calibration (S2)		-10	0	10	

* According to the set-up wizard.

Inputs and outputs

Level 1	Level 2	Description	Values	Min.	Def.	Max.
In0	o00	AUX1 relay configuration: 0= Deactivated, 1= Compressor/Crankcase resistance, 2= Light, 3= Virtual control, 4= Alarm, 5= Door frame resistor, 6=Drainage resistor		0	*	6
	o10	AUX2 relay configuration: 0= Deactivated, 1= Alarm, 2= Light, 3= Virtual control, 4= Defrost 2nd evaporator, 5= Door frame resistor, 6= Equal solenoid status, 7= Equal device status, 8=Drainage resistor		0	2	8
	o20	AUX3 relay configuration: 0= Deactivated, 1= Alarms, 2= Light, 3= External AO controller ON/OFF, 4=Defrost 2nd evaporator, 5= Door frame resistor, 6=Drainage resistor		0	0	6
	o30	Analogue output type (AO): 0= 4-20mA, 1= 0-10V		0	0	1
	EP	Output to level 1				

HACCP alarm

Level 1	Level 2	Description	Values	Min.	Def.	Max.
HCP	h1	HACCP alarm maximum temperature	°C/°F	-50	99.0	99.0
	h2	Maximum permitted time for activation of the HACCP alarm (0=HACCP alarm deactivated)	h.	0	0	255
	EP	Output to level 1				

Information (read-only)

Level 1	Level 2	Description	Values	Min.	Def.	Max.
tid	InI	Option chosen in the configuration wizard				
	Pd	Pump down active? 0=No, 1=Yes				
	PU	Program version				
	Pr	Program revision				
	PSr	Program subrevision				
	bU	Bootloader version				
	br	Bootloader revision				
	bSr	Bootloader subrevision				
	PAr	Parameter map revision				
	EP	Output to level 1				

* According to the set-up wizard.

Connectivity

The controllers are equipped with a port for connection of RS485 (MODBUS) data, which allows for remote management of these using a AKO-5010, AKO-5025, AKO-5041 or AKO-5051 gateway.

The MODBUS address is factory-set and is indicated on the rating plate located on the left side of the controller. This address must be different for each unit within the same network. The address can be changed using parameter **b20**. Once modified, the old address indicated on the plate will not be valid.

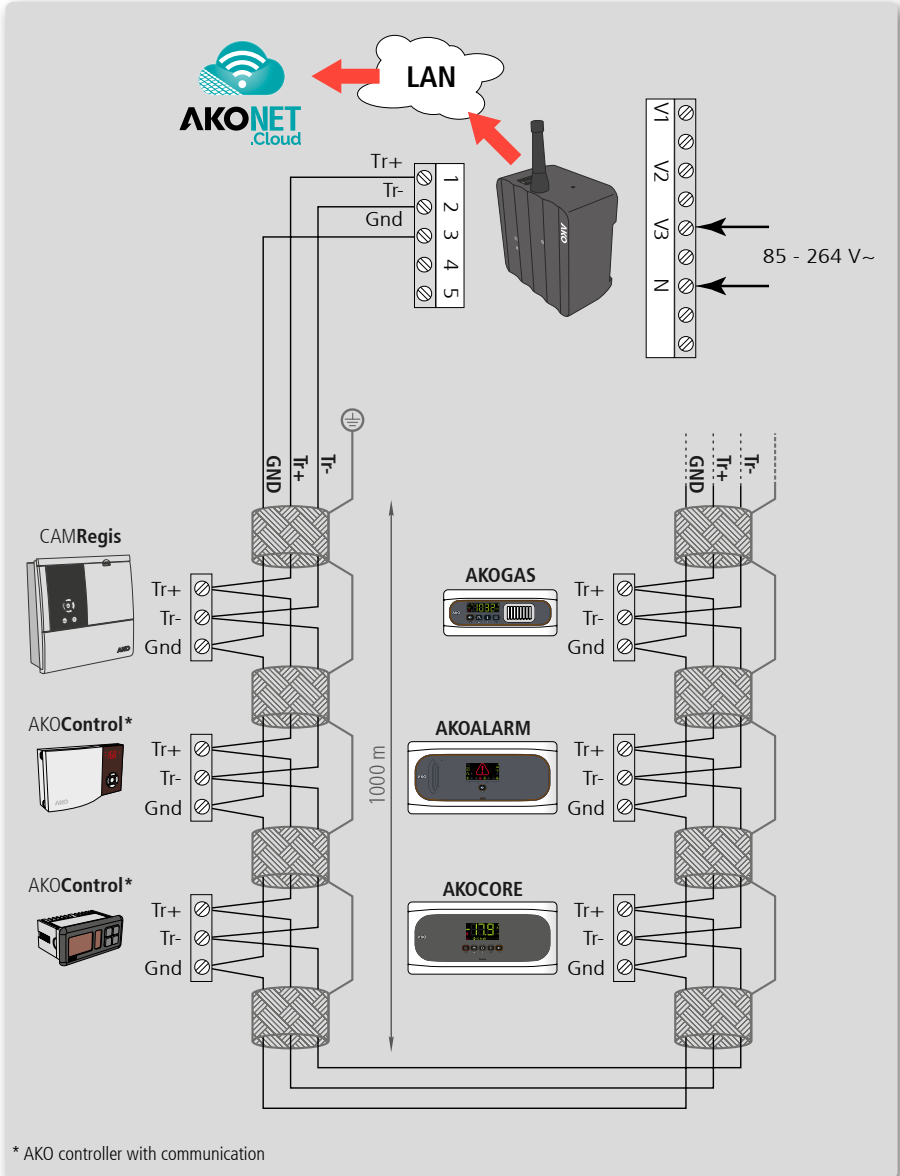

* AKO controller with communication

Technical specifications

Power supply.....	100 - 240 V ~ 50/60 Hz
Maximum input power in the operation	8.1 VA
Maximum nominal current.....	15 A
DEF relay - SPDT - 20 A NO (EN 60730-1: 15 (15) A 250 V~)	
NC.....	(EN 60730-1: 15 (13) A 250 V~)
FAN relay - SPST - 16 A (EN 60730-1: 12 (9) A 250 V~)	
Relay COOL - SPST - SSR 2 A Vmax: 275 V~, Imax: 2 A	
AUX relay 1 - SPDT - 20 A	NO.....(EN 60730-1: 15 (15) A 250 V~)
	NC.....(EN 60730-1: 15 (13) A 250 V~)
AUX relay 2 - SPDT - 16 A	NO.....(EN 60730-1: 12 (9) A 250 V~)
	NC.....(EN 60730-1: 10 (8) A 250 V~)
AUX relay 3 - SPST - 16 A	NO.....(EN 60730-1: 12 (9) A 250 V~)
No. of relay operations	EN 60730-1:100,000 operations
Sensor temperature range	-50.0 °C to 99.9 °C
Resolution, adjustment and differential.....	0.1 °C
Thermometric accuracy	±1 °C
Tolerance of the NTC probe at 25 °C.....	±0.4 °C
Input for NTC probe	AKO-14950 / AKO-14950-8
Working ambient temperature	-10 °C to 50 °C
Ambient storage temperature	-30 °C to 60 °C
Protection degree	IP 65
Installation category.....	II as per EN 60730-1
Degree of pollution	II as per EN 60730-1
Grade as per UNE-EN 60730-1: Built-in control device, with Type 1.B automatic action operation feature, for use in clean situations, logical support (software) class A and continuous operation. Degree of pollution 2.	
Double isolation between power supply, secondary circuit and relay output.	
Accessible parts pressure ball test temperature	75 °C
Parts positioning active elements.....	125 °C
Radio interference suppression test current.....	270 mA
Voltage and current delayed by the EMC tests.....	207 V, 17 mA
Type of mounting.....	Fixed interior
MODBUS address.....	Indicated on the label
Dimensions	290 mm (W) x 141 mm (H) x 84.4 mm (D)
Internal buzzer	

AKO-16526AN

Maximum transmission power	23.5 dBm conducted
Antenna.....	Internal
Bands	NB1oT (Narrow band) LTE Cat NB1 B2, B3, B4, B8, B12, B13, B20

Band	Rx Frequency	Tx Frequency
2	1930 MHz ~ 1990 MHz	1850 MHz ~ 1910 MHz
3	1805 MHz ~ 1880 MHz	1710 MHz ~ 1785 MHz
4	2110 MHz ~ 2155 MHz	1710 MHz ~ 1755 MHz
8	925 MHz ~ 960 MHz	880 MHz ~ 915 MHz
12	729 MHz ~ 746 MHz	699 MHz ~ 716 MHz
13	746 MHz ~ 756 MHz	777 MHz ~ 787 MHz
20	791 MHz ~ 821 MHz	832 MHz ~ 862 MHz

Simplified declaration of conformity

AKO Electromecánica S.A. hereby declares that the radioelectric device types AKO-16526AN (Advanced temperature controller for cold rooms with NBloT communication) conform to the provisions set forth by Directive 2014/53/EU.

The full text of the EU conformity declaration is available at the following internet address:

<http://help.ako.com/manuales/declaracion-ue-de-conformidad>

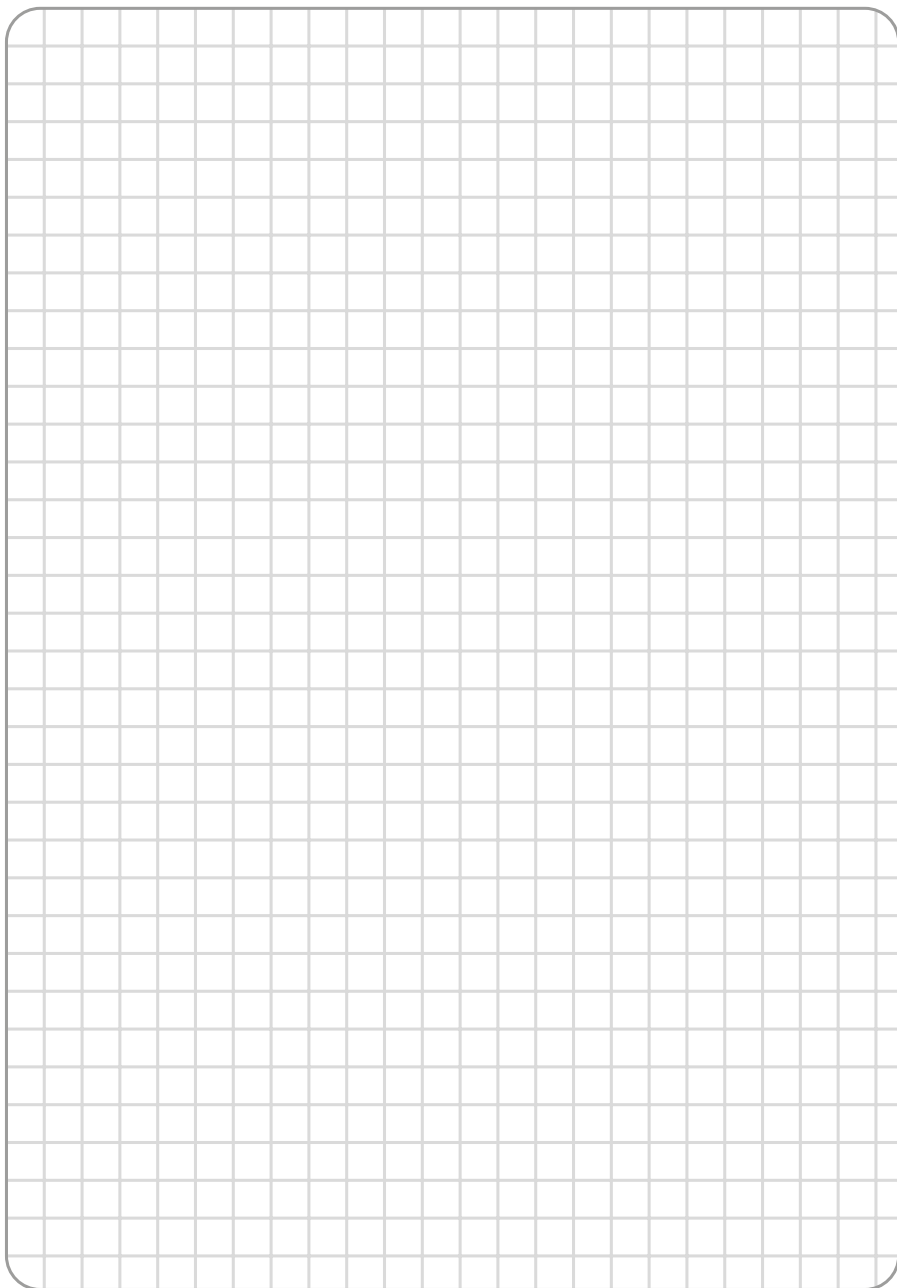

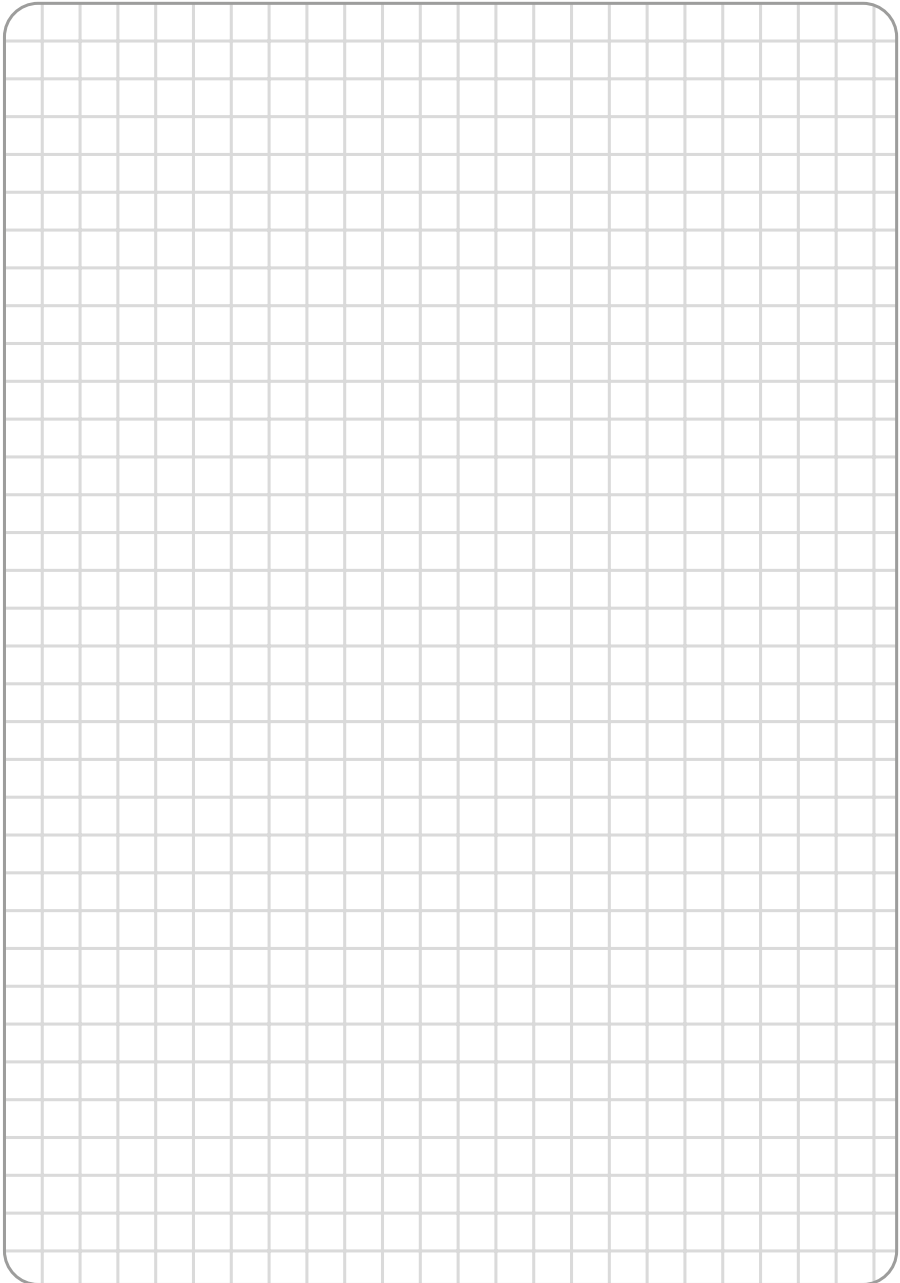

AKO ELECTROMECÁNICA, S.A.
Avda. Roquetes, 30-38
08812 • Sant Pere de Ribes.
Barcelona • Spain

www.ako.com

351.6526A32 Rev. 04 2024

We reserve the right to supply materials slightly different to those described in our Data Sheets. Updated information in our website.